

© Texas Instruments Incorporated 1983

All Rights Reserved, Printed in U.S.A

The information and/or drawings set forth in this document and all rights in and to inventions disclosed herein and patents which might be granted thereon disclosing or employing the materials, methods, techniques or apparatus described herein, are the exclusive property of Texas Instruments Incorporated.

MANUAL REVISION HISTORY

Model 931 Video Display Terminal General Description (2229228-0001)

Original Issue 1 August 1983

Revision A 15 December 1983

The total number of pages in this publication is 165.

IMPORTANT

Record the serial number and purchase date of the TI Terminal in the space below. The serial number is identified by the words "SERIAL NO." on the unit. Always reference this information in any correspondence.

TI Terminal

Model No. _____ Serial No. _____ Purchase Date _____

Preface

This manual describes the Texas Instruments OPTI 900* Model 931 Video Display Terminal (VDT) and provides technical information and procedures for its installation and connection to a host computer. It contains system programming information for developing service routines to control terminal functions. Operating instructions and diagnostic procedures are also included.

Section

- 1 General Description — Describes the major features and lists the specifications of the Model 931 VDT.
- 2 Installation — Provides installation instructions for the Model 931 VDT. Includes unpacking procedures, space and power requirements, environmental considerations, preparation of the terminal for operation, power-up, and checkout.
- 3 Communications — Contains general information for connecting the Model 931 VDT to a Texas Instruments computer system. Includes types of installation, communications interfaces, modems, cable requirements, and printer installation.
- 4 Configuration — Provides instructions for setting communications parameters at the terminal.
- 5 Programming — Contains programming information to suit the terminal for specific applications. Includes a detailed description of host commands.
- 6 Operation — Provides instructions for operating the Model 931 VDT, including equipment description, adjusting the terminal for use, establishing communications, care, and cleaning.
- 7 Diagnostics — Provides tests to solve simple problems and diagnostic information used by the customer representative. Includes diagnostic procedures, error messages and their interpretation, fault isolation indicators, and unit diagnostic tests.

* Trademark of Texas Instruments Incorporated

Appendix

- A International Keyboards — Contains the various international keyboards and ASCII character charts.
- B Codes and Character Sets — Provides the ASCII character codes and control functions, conversion table, command codes, and row and column addressing.
- C Key Codes — Shows the ASCII and hexadecimal codes for different modes of the keyboard.
- D Interfaces and Cables — Provides pin assignments for the cables and interfaces for the Model 931 VDT.

GLOSSARY

INDEX

OTHER PUBLICATIONS AVAILABLE

The following manuals also describe the Model 931 VDT:

Title	Part Number
<i>Model 931 Video Display Terminal Field Maintenance Manual</i>	2229229-0001
<i>Model 931 Video Display Terminal Depot Maintenance Manual</i>	2229230-0001

Contents

Paragraph	Title	Page
1 — General Information		
1.1	Introduction	1-1
1.2	Terminal Features	1-1
2 — Installation		
2.1	Introduction	2-1
2.2	Unpacking the Model 931 VDT	2-1
2.2.1	Shipping Container Contents	2-1
2.2.2	Unpacking Procedure	2-2
2.3	Installation Specifications for the Model 931 VDT	2-4
2.4	Preparing the Terminal for Operation	2-7
2.4.1	Tilt-Base Installation	2-7
2.4.2	Keyboard Angle Adjustment	2-11
2.4.3	Back Panel of the Display Unit	2-12
2.4.4	Connecting the Keyboard with the VDU	2-13
2.5	Interfacing the Model 931 VDT with a Host Computer	2-14
2.5.1	Connecting the Model 931 VDT Directly to a Host Computer	2-14
2.5.2	Fiber-Optics Cable	2-16
2.5.3	Connecting a Modem to the Terminal	2-17
2.5.4	Modem Settings	2-17
2.5.5	Connecting the Model 931 VDT to a Printer	2-17
2.5.6	Extension Cables	2-18
2.5.7	AC Check	2-18
2.5.8	AC Power Cord Connection	2-19
2.6	Power-Up and Checkout	2-21
2.6.1	Warm-Up and Self-Test Sequence	2-21
2.6.2	Standby	2-21
3 — Communications		
3.1	Introduction	3-1
3.2	Types of Installations	3-1
3.3	Direct Configurations	3-1
3.4	Remote Configurations	3-5
3.5	Extension Cables	3-7
3.6	Modem Settings	3-9

Paragraph	Title	Page
-----------	-------	------

4 —Configuration

4.1	Introduction	4-1
4.2	Programmer Configuration Mode	4-1
4.3	Communications (Comm) Port	4-2
4.3.1	Configuring Comm Port Parameters	4-2
4.3.2	Comm Port Menus	4-3
4.4	Auxiliary (Aux) Output Port	4-4
4.4.1	Configuring Aux Port Parameters	4-4
4.4.2	Aux Port Menus	4-5
4.5	Display (Dsply)	4-6
4.5.1	Configuration Display Parameters	4-6
4.5.2	Display Menus	4-7
4.6	Protected Keyboard Functions (Keybd)	4-8
4.6.1	Configuring Protected Keyboard Functions	4-8
4.6.2	Protected Keyboard Menu	4-8
4.7	Diagnostics (Diag)	4-9

5 —Programming

5.1	Introduction	5-1
5.2	Terminal Control Commands	5-8
5.2.1	Device Control 3	5-8
5.2.2	Device Control 1	5-8
5.2.3	Bell	5-8
5.2.4	Back Space	5-9
5.2.5	Carriage Return	5-9
5.2.6	Line Feed	5-9
5.3	Cursor Control Commands	5-9
5.3.1	Cursor Off	5-9
5.3.2	Cursor On	5-9
5.3.3	Enable/Disable Cursor Blink	5-10
5.3.4	Cursor Down	5-10
5.3.5	Cursor Home	5-10
5.3.6	Cursor Left	5-10
5.3.7	Cursor Right	5-10
5.3.8	Cursor Up	5-10
5.3.9	Set Cursor Address	5-11
5.4	Erase Commands	5-11
5.4.1	Erase to End of Line	5-11
5.4.2	Erase to End of Screen	5-11
5.4.3	Erase All	5-11
5.4.4	Erase to Address	5-12
5.5	Screen Editing Commands	5-12
5.5.1	Scroll Down	5-12
5.5.2	Scroll Up	5-12
5.5.3	Move Box	5-13

Paragraph	Title	Page
5.5.4	Line Insert/Delete Commands	5-13
5.5.4.1	Line Editing Extent Boundary	5-13
5.5.4.2	Insert Line	5-13
5.5.4.3	Delete Line	5-14
5.5.5	Character Insert/Delete Commands	5-14
5.5.5.1	Enable/Disable Character Editing Extent Mode	5-14
5.5.5.2	Select Character Editing Extent Boundary	5-15
5.5.5.3	Select Fill Character and Attribute	5-15
5.5.5.4	Insert Character	5-15
5.5.5.5	Delete Character	5-15
5.5.6	Repeat Commands	5-15
5.5.6.1	Repeat to Address	5-16
5.5.6.2	Repeat Character N Times	5-16
5.6	Attribute Commands	5-16
5.6.1	Attribute Latch	5-19
5.6.1.1	Set Display Attribute	5-19
5.6.1.2	Attribute AND and Attribute OR	5-19
5.6.2	Memory	5-20
5.6.3	Repeat Attribute to Address	5-20
5.6.4	Repeat Attribute N Times	5-20
5.7	Character Set Selection Commands	5-20
5.7.1	Select and Enter Alternate Character Set	5-21
5.7.2	Select Alternate Character Set	5-21
5.7.3	Select Primary Character Set	5-21
5.8	Keyboard Commands	5-21
5.8.1	Keyboard Lock	5-21
5.8.2	Keyboard Unlock	5-21
5.9	Video Commands	5-21
5.9.1	Video Off	5-22
5.9.2	Video On	5-22
5.10	Auxiliary Device Control Commands	5-22
5.10.1	Write Data to Device (Transparent Print)	5-22
5.10.2	Printer Acknowledge	5-22
5.10.3	Cancel Output	5-23
5.11	Status Line Control Commands	5-23
5.11.1	Write to Message Area	5-23
5.11.2	Erase Message	5-23
5.11.3	Write to and Select Alternate Status Line	5-23
5.11.4	Restore Primary Status Line	5-23
5.12	Terminal Reporting Commands	5-24
5.12.1	Read to Address	5-24
5.12.2	Read Cursor Position	5-24
5.12.3	Read Status	5-24
5.12.4	Enquiry	5-26
5.12.5	Report Terminal ID	5-27
5.13	Configuration Commands	5-27
5.13.1	Comm Port Parameters	5-27
5.13.2	Aux Port Parameters	5-29
5.13.3	Operational Parameters	5-30

Paragraph	Title	Page
5.13.4	Answerback Memory (ABM)	5-31
5.13.5	Enable/Disable Personality Module Mode	5-31
5.13.6	Reset Nonvolatile Memory	5-31
5.14	Diagnostic Commands	5-31
5.14.1	Execute RAM Test	5-32
5.14.2	Verify All ROMs	5-32
5.14.3	B-pole All Character Sets	5-32
5.14.4	VDU Adjust Pattern	5-33
5.14.5	Enter Keyboard Test Mode	5-33
5.14.6	Exit Keyboard Test Mode	5-33
5.14.7	External Loopback Test	5-33
5.15	Miscellaneous Commands	5-33
5.15.1	Control Start	5-33
5.15.2	Control End	5-34

6 — Operation

6.1	Introduction	6-1
6.2	Video Display Unit Description	6-1
6.2.1	Main Display Area	6-2
6.2.2	Status Line	6-2
6.2.2.1	Host Message Area	6-3
6.2.2.2	Terminal Status Area	6-3
6.2.3	Alternate Status Line	6-5
6.3	Keyboard Description	6-6
6.4	Terminal Adjustments	6-9
6.5	Establishing Communications	6-11
6.6	Care and Cleaning	6-11
6.6.1	Display Screen	6-11
6.6.2	Other Exterior Surfaces	6-11

7 — Diagnostics

7.1	Introduction	7-1
7.2	General Troubleshooting Guide	7-1
7.2.1	Self-Tests	7-1
7.2.2	Identifying Malfunction Categories	7-2
7.2.3	Blank Display Diagnosis	7-3
7.2.4	Communications Diagnosis	7-6
7.2.5	Printer Diagnosis	7-8
7.3	Internal Diagnostics	7-9
7.3.1	ROM (Read Only Memory) Test	7-10
7.3.2	RAM (Random Access Memory) Test	7-10
7.3.3	N-V RAM (Non-Volatile RAM) Test	7-10
7.3.4	B-pole Test	7-10
7.3.5	Pattern	7-10
7.3.6	Factory	7-10

Paragraph	Title	Page
7.3.7	Loopback Test	7-11
7.3.8	Keyboard Test	7-12
7.3.9	Reset	7-12
7.4	Online Confidence Tests	7-12

Appendixes

Appendix	Title	Page
A	International Keyboards	A-1
B	Codes and Character Sets	B-1
C	Key Codes	C-1
D	Interfaces and Cables	D-1

Glossary

Index

Illustrations

Figure	Title	Page
1-1	Model 931 Video Display Terminal	1-2
1-2	The Model 931 VDT in a Systems Environment	1-3
2-1	Shipping Container Contents	2-2
2-2	Model 931 VDT Physical Dimensions	2-3
2-3	Attaching the Model 931 VDT Tilt-Base Assembly	2-8
2-4	Securing the Model 931 VDT Tilt-Base Assembly	2-9
2-5	Installed Tilt-Base Assembly	2-10
2-6	Keyboard Angle Adjustment	2-11
2-7	Lower Back Panel of the Model 931 VDT	2-12
2-8	Keyboard Cable Connection	2-13
2-9	EIA Communications Cable Connection	2-15
2-10	Fiber-Optics Cable Connection	2-16
2-11	EIA Auxiliary Output Cable Connection	2-18
2-12	Three Wire, Earth-Grounded Electric Wall Outlet	2-19
2-13	AC Power Cord Connection	2-20
3-1	Direct and Remote Model 931 VDT/Host Configurations	3-2
5-1	Display Attribute Bit Pattern Settings	5-17
5-2	Status Byte Code Format	5-25
6-1	Model 931 VDT Screen Areas	6-2
6-2	Primary Status Line Format	6-3
6-3	US Standard Keyboard	6-7
6-4	Keyboard—Alternate Selection	6-9
7-1	Fault Isolation Indicators—Self-Test and Power Good LEDs	7-4
7-2	Model 931 VDT Power Fuse Condition	7-5
7-3	Fault Isolation Indicators—Transmit and Receive LEDs	7-7
7-4	B-pole Test Pattern	7-11
A-1	United States Keyboard and Character Sets	A-2
A-2	Danish/Norwegian Keyboard and Character Sets	A-3
A-3	French Data Processing Keyboard and Character Sets	A-4
A-4	French Word Processing Keyboard and Character Sets	A-5
A-5	German/Austrian Keyboard and Character Sets	A-6
A-6	Spanish Keyboard and Character Sets	A-7
A-7	Swedish/Finnish Keyboard and Character Sets	A-8
A-8	Swiss Keyboard and Character Sets	A-9
A-9	United Kingdom Keyboard and Character Sets	A-10
A-10	Data Entry and Editing — US Keyboard	A-12
A-11	Terminal Convenience Adjustment	A-13
A-12	Terminal Control Function Keyboard Mode	A-14
A-13	Terminal Control Code Keyboard Modes (Unprotected)	A-16
A-14	Terminal Control Code Keyboard Modes (Protected)	A-17
C-1	Keyboard Reference for Key Code Tables	C-2

Tables

Table	Title	Page
1-1	Model 931 VDT Features	1-3
2-1	Model 931 VDT Installation Specifications	2-4
3-1	Direct Connect Interfaces, 990/10A Computer to the Model 931 VDT	3-3
3-2	Direct Connect Interfaces, S600 and S800 Computers to the Model 931 VDT	3-3
3-3	Direct Connect Interfaces, S300 Computer to the Model 931 VDT	3-4
3-4	Remote Interfacing, S600 and S800 Computers to Modem	3-6
3-5	S300 Computer to Modem, Communications Interfaces	3-7
3-6	Extension Cables	3-8
3-7	Recommended Settings for the Bell 212A Modem	3-9
4-1	Protected CTRL Key Functions	4-8
4-2	Protected ALT Key Functions	4-9
5-1	Host Computer Commands	5-3
5-2	ASCII Characters and Hex Codes for Display Attributes	5-18
5-3	ASCII Characters and Codes for Status Responses	5-26
5-4	ASCII Characters and Codes for Comm Port Configuration	5-28
5-5	ASCII Characters and Codes for Aux Port Configuration	5-29
5-6	ASCII Characters and Hex Codes for Operational Parameters	5-30
6-1	Terminal Status Line Messages	6-4
6-2	Keyboard Mode Key Selections and Functions	6-8
6-3	Model 931 VDT Terminal Adjustments	6-10
7-1	Terminal Error Messages	7-2
A-1	Data Entry and Editing	A-11
A-2	Terminal Command Functions	A-15
B-1	US ASCII Character Codes	B-2
B-2	US ASCII Control Code Functions	B-3
B-3	ASCII Value Actions Performed When Preceded by ESC	B-4
B-4	Row and Column Addressing	B-6
B-5	Move Box Row and Column Count Codes	B-7
B-6	Repeat Count Values	B-8
C-1	Mode Key Codes	C-3
C-2	Key Codes — Row 1	C-4
C-3	Key Codes — Row 2	C-6
C-4	Key Codes — Row 3	C-8
C-5	Key Codes — Row 4	C-10
C-6	Key Codes — Row 5	C-12
C-7	Key Codes — Row 6	C-14
D-1	EIA RS-232-C Interface Signal Pin Assignments	D-1
D-2	Model 931 VDT COMM Connector Pin Assignments	D-3
D-3	Model 931 VDT AUX-1 Connector Pin Assignments	D-4
D-4	Direct Connect Cable Pin Assignments	D-5

Contents

Paragraph	Title	Page
D-5	Host/Modem Cable Pin Assignments	D-6
D-6	Host/Modem, Modem/Model 931 VDT Cable Pin Assignments	D-7
D-7	Fiber Optics Cable Pin Assignments	D-8
D-8	Printer/Model 931 VDT or S300/Model 931 VDT, Cable Pin Assignments	D-8
D-9	EIA Extension Cable 2303071 Pin Assignments	D-9
D-10	Fiber Optics Extension Cable 2233201 Pin Assignments	D-9

General Information

1.1 INTRODUCTION

This section describes the major features and specifications of the Texas Instruments Model 931 Video Display Terminal (VDT). The Model 931 VDT is a state-of-the-art systems terminal designed to interface with and complement the versatile Texas Instruments Small Business Systems 300, 600 and 800 series computers. The terminal, shown in Figure 1-1, consists of a video display unit (VDU) and a detachable keyboard. It communicates with the host computer by means of a communications interface and appropriate cable.

Communications protocol is accomplished with RS-232-C interface levels using 7-bit ASCII data. Optional fiber-optics communications are available for all direct connect applications where electrical connection is not appropriate. The fiber-optics interface is functionally equivalent to the RS-232-C interface, but transmission is accomplished with pulses of light that are not subject to electrical interference.

The Model 931 VDT is a system terminal and is intended for online operation. Offline, it can be physically connected to a host system but it neither transmits nor receives data. Keyboard input is copied only to the screen. The terminal drives a printer that can be activated by the host through the terminal while the operator at the terminal retains full use of the Model 931 VDT.

The VDU and keyboard can be placed on a desk or table for convenient operation.

1.2 TERMINAL FEATURES

A communications sequence is set in motion each time a key is pressed on the keyboard of the Model 931 VDT. The sequence follows:

1. A key code is transmitted from the keyboard to the VDU microprocessor. The VDU microprocessor interprets the keyboard signal and transmits to the host computer a unique ASCII code or code sequence for each keystroke.
2. This code can be:
 - a. Echoed back to the terminal and displayed as a character on the VDU.
 - b. Interpreted by the host Device Service Routine (DSR), which generates a command to control a terminal function.
3. When the terminal receives the command, it performs the function entered by the operator.

General Information

The communications sequence between the Model 931 VDT and the host computer is shown in Figure 1-2.

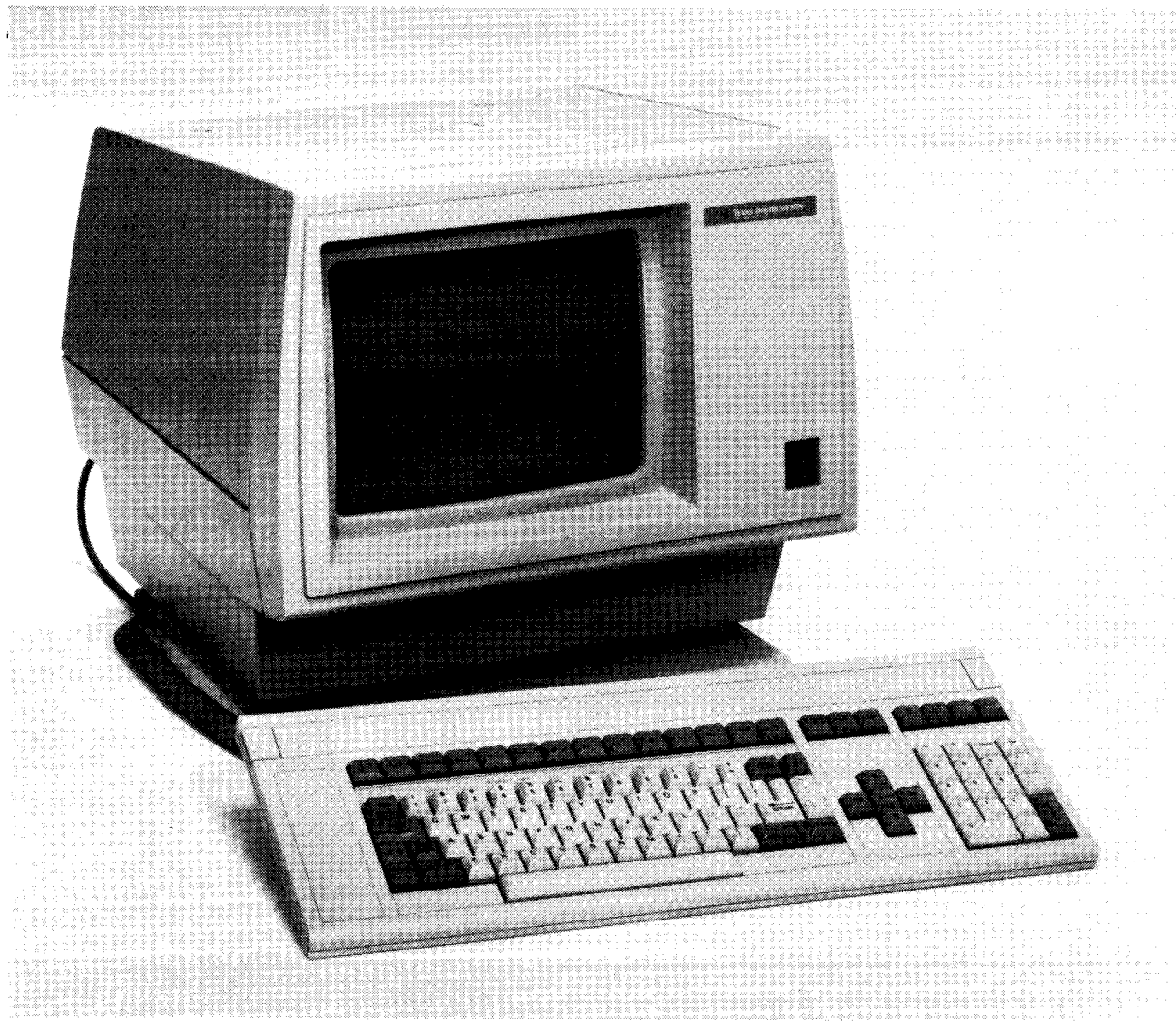
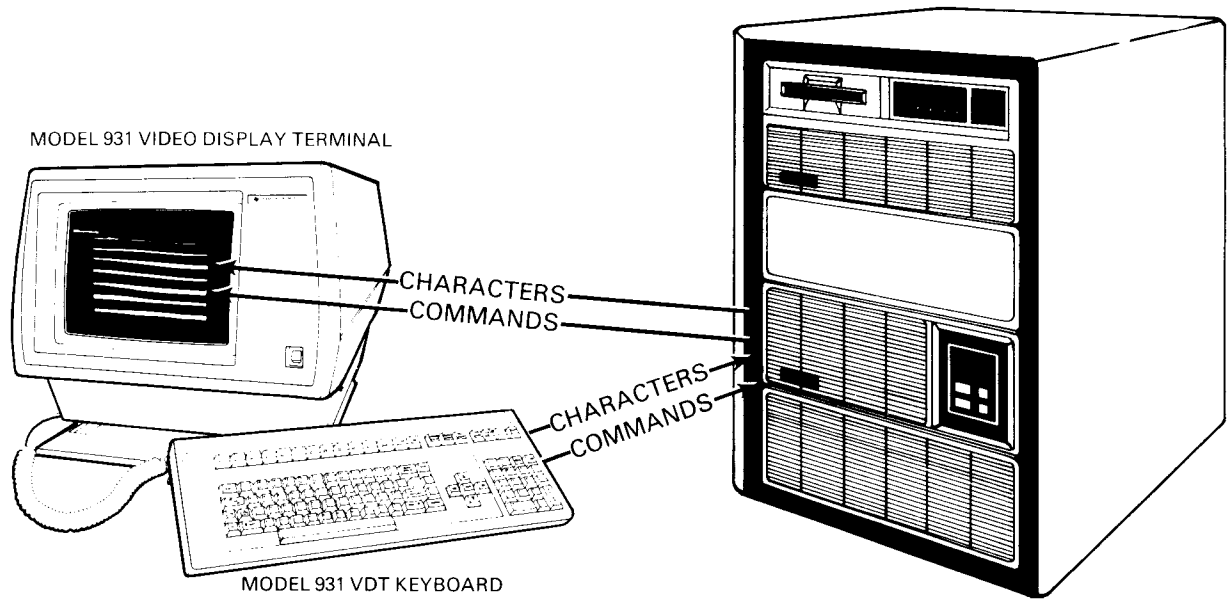

Figure 1-1. Model 931 Video Display Terminal

2229228-1



2229228-2

Figure 1-2. The Model 931 VDT in a Systems Environment

Table 1-1 briefly describes the features of the Model 931 VDT.

Table 1-1. Model 931 VDT Features

Feature	Description
Keyboard	<p>Detached, low profile, adjustable tilt</p> <p>Standard typewriter layout</p> <p>Tactile feedback</p> <p>Calculator-style numeric keypad</p>

Table 1-1. Model 931 VDT Features (Continued)

Feature	Description
Display Screen	<ul style="list-style-type: none"> Adjustable-tilt video display unit 12-inch (diagonal measure) cathode ray tube 9 x 14 character cell One-half dot shift (enhanced character definition) 80 columns X 25 rows Reverse screen image Video enable/disable control Discrete scrolling Status line message area 16 brightness levels 50 or 60 Hz frame refresh rate 350 active scan lines
Character Sets	<ul style="list-style-type: none"> 96 displayable ASCII characters 32 displayable line drawing characters True underline capability Lowercase descenders (g, j, p, q, y)
Character Attributes	<ul style="list-style-type: none"> High intensity Blink Blank (nondisplay for security) Underline Reverse character image

Table 1-1. Model 931 VDT Features (Concluded)

Feature	Description
Cursor Position	Cursor up, down, right, left, home Carriage (cursor) return (CR) Backspace Addressable cursor
Cursor Attributes	Block or underline Full 9 x 14 character block Displayed Nondisplayed Reverse image Blink

Specifications for the physical dimensions and power as well as environmental requirements for the Model 931 VDT are listed in Section 2, "Installation."

Installation

2.1 INTRODUCTION

This section provides instructions for installing the Model 931 VDT, including:

- Unpacking procedures
- Space and power requirements
- Environmental considerations
- Preparing the terminal for operation
- Terminal power-up/power-down and checkout procedures

Instructions for connecting the terminal with a host system are in Section 3, “Communications.”

2.2 UNPACKING THE MODEL 931 VDT

When the Model 931 VDT arrives, be sure to check the contents of the container with the list below and follow the unpacking procedures in the text.

2.2.1 Shipping Container Contents

The container holds five basic items:

- Keyboard module
- Video display unit
- Power cord
- *Model 931 VDT General Description and Quick Reference Guide*
- Tilt-base kit

These items are shown in Figure 2-1.



2229228-3

Figure 2-1. Shipping Container Contents

2.2.2 Unpacking Procedure

1. Carefully inspect the shipping container. Report any apparent container damage to the shipping agent.
2. Be sure the shipping container is upright. Remove all straps securing the shipping container.
3. Using a sharp knife, cut the tape securing the flaps on top of the container and open the flaps.
4. Gently remove the fitted foam packs containing the terminal components. Place each one on a flat, sturdy surface and unpack it carefully. Make sure the five basic items are present (Figure 2-1).

5. Closely inspect the items for damage. Note any damage and follow local procedures for handling damaged shipments.
6. Save the shipping container and foam packing materials for possible reshipment or relocation of the Model 931 VDT.

CAUTION

If the terminal is damaged, contact your dealer or qualified Customer Representative to correct the problem before applying power to the unit.

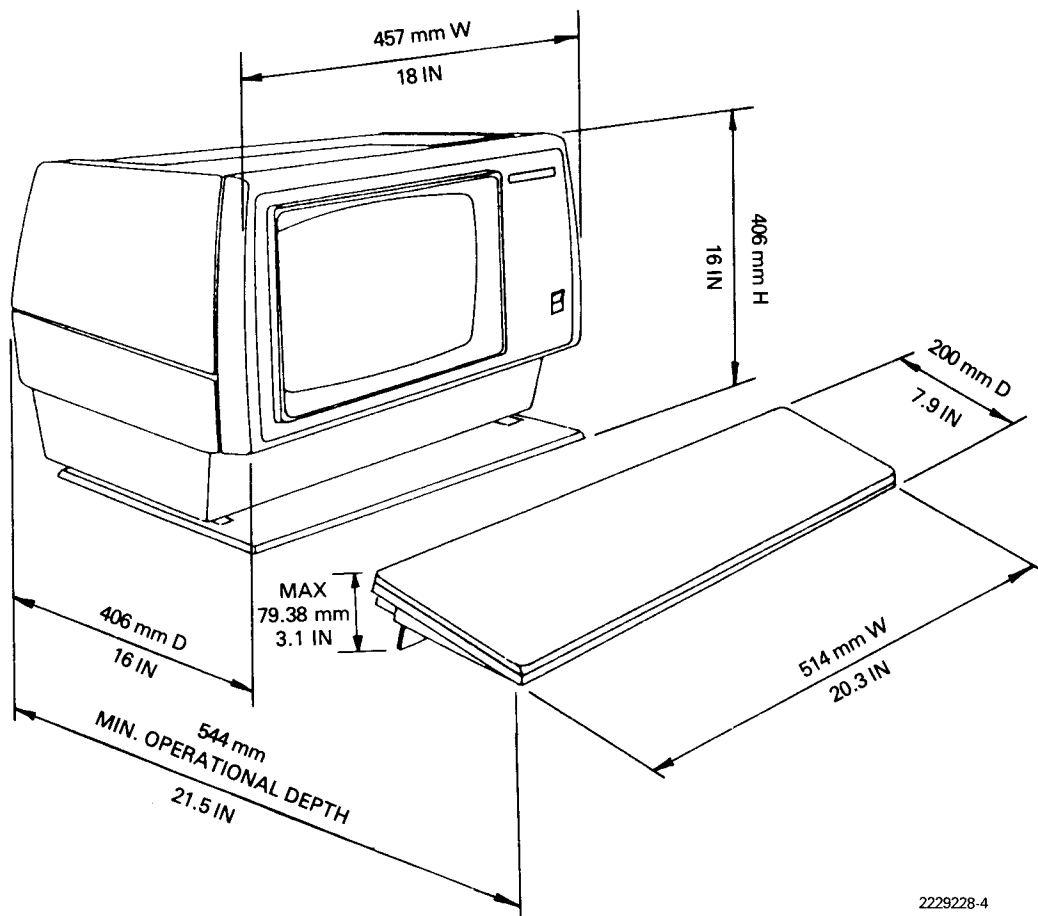

2229228-4

Figure 2-2. Model 931 VDT Physical Dimensions

2.3 INSTALLATION SPECIFICATIONS FOR THE MODEL 931 VDT

The physical dimensions of the Model 931 VDT are listed in Table 2-1 and shown in Figure 2-2. Table 2-1 also lists power and environmental requirements, video display features, and data communication characteristics. Refer to this table to familiarize yourself with the installation specifications for your terminal. Pay close attention to the cautionary statements in the text following the table.

Table 2-1. Model 931 VDT Installation Specifications

Features	Specifications			
Physical Dimensions	(Nominal)			
	Height	Width	Depth	Weight
Video Display Unit: (Without tilt base)	378.0 mm (14.88 in)	457.0 mm (18.00 in)	406.0 mm (16.00 in)	9.5 kg (21 lb)
Video Display Unit: (With tilt base)	406.0 mm (16.00 in)	457.0 mm (18.00 in)	406.0 mm (16.00 in)	9.8 kg (22 lb)
Keyboard: (Support retracted)	35.0 mm (1.40 in)	514.0 mm (20.30 in)	200.0 mm (7.90 in)	2.3 kg (5 lb)
Keyboard: (Support extended)	79.38 mm (3.125 in)	514.0 mm (20.30 in)	200.0 mm (7.90 in)	2.3 kg (5 lb)
Power Requirements				
Line Voltage:	120, 220 or 240 Vac, single phase ¹			
Line Frequency:	50 or 60 Hz			
Power Connectors:	IEC standard three prong			
Power Cord:	1.9 m (6 ft) long (Domestic, European, United Kingdom)			
Environmental Requirements				
Storage (in shipping container)				
Temperature:	- 30° C to 65° C (- 22° F to 149° F)			
Relative Humidity:	10% to 90%, noncondensing			
Altitude:	Up to 12 195 m (40 000 ft) above mean sea level			

Table 2-1. Model 931 VDT Installation Specifications (Continued)

Features	Specifications
Operating	
Temperature:	10° C to 40° C (50° F to 104° F)
Relative Humidity:	20% to 80%, noncondensing
Altitude:	Up to 3049 m (10 000 ft) above mean sea level ²
Video Display Features	
Display Size:	304.8 mm (12 in) measured diagonally
Character Capacity:	25 lines of 80 characters
Character Size:	7 × 9 pixels
Cursor Size:	9 × 14 pixels
Character Image:	Normal and reverse background
Display Intensities:	Normal and high
Communication Characteristics	
Comm Port	
Code:	US ASCII or IA5
Protocol:	Full duplex
Method:	Asynchronous serial
Standard Interface:	EIA/RS-232-C or CCITT
Optional Interface:	Fiber optics
Speed:	300, 600, 1200, 2400, 4800, 9600, and 19 200 bps
Parity:	Even, odd, mark, space No parity check Received parity check

Table 2-1. Model 931 VDT Installation Specifications (Concluded)

Features	Specifications
Aux Port	
Code:	US ASCII or IA5
Protocol:	Full duplex, transmit only
Method:	Asynchronous serial
Standard Interface:	EIA/RS-232-C or CCITT
Speed:	300, 600, 1200, 2400, 4800, and 9600 bps
Parity:	Even, odd

Notes:

¹ Voltage required to operate the Model 931 VDT is recorded on a label next to the power cord receptacle on the back of the VDU. See Figure 2-3.

² The upper operating limit for temperature falls one degree for each 305 m (1000 ft) over 153 m (500 ft) above mean sea level.

Observe the following cautions:

- Be sure to place the Model 931 VDT on a desk or table strong enough to support at least 13.6 kg (30 lb), which is the combined weight of the video display and keyboard.
- The keyboard cable is tensioned at the factory. If the keyboard is to be placed apart from the display unit, the cable may need to be flexed. To flex the cable, grasp both ends and fully extend the cable, then relax it five or six times. This lessens the force of the coil action.
- The terminal is cooled by convection. Air drawn in through vents on the base and rear of the terminal moves upward (as temperatures rise inside the terminal housing) and is expelled through vents on top of the terminal. If two terminals are placed back to back, allow at least 305 mm (12 in) of space between them for proper ventilation.
- If the terminal is mounted in an enclosure, such as in a cabinet with only its screen showing, use a suitable forced-air cooling system to avoid overheating the terminal.
- Do not operate the terminal when its cooling vents are blocked. Overheating may damage the electronics.

- Do not store the terminal in an environment having temperatures outside the storage temperature range of -30°C to 65°C (-22°F to 149°F). (These temperatures apply only to a terminal in the original shipping container.)
- Do not use the terminal in an environment having temperatures outside the operating temperature range of 10°C to 40°C (50°F to 104°F). If the terminal has been stored outside this range, allow it to sit in its operating environment for at least 30 minutes before applying power.
- Do not spill liquids or drop items such as staples and paper clips into the VDU. Severe damage to electrical components can result.

2.4 PREPARING THE TERMINAL FOR OPERATION

The following paragraphs describe tilt-base installation and cable connections.

2.4.1 Tilt-Base Installation

The standard tilt base for the Model 931 is packed in the shipping container beneath but separate from the VDU. The base allows the operator to tilt the VDU to the desired viewing angle with one hand.

Install the tilt base this way:

1. Carefully place the VDU face down on a flat, padded surface with the base facing you.
2. Remove the tilt base from its plastic container. Align it with the VDU so that the black, plastic support post on the tilt base is opposite the support post attached to the base of the terminal.

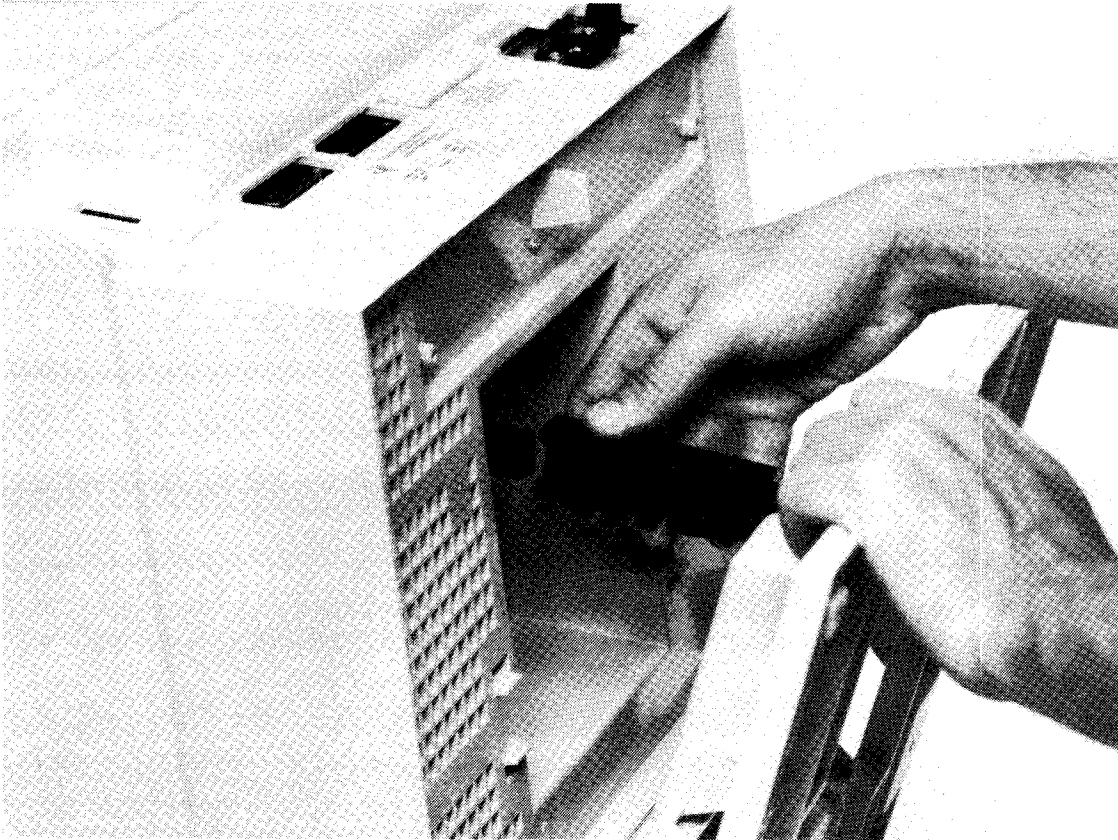

2229228-5

Figure 2-3. Attaching the 931 VDT Tilt-Base Assembly

CAUTION

Be sure the terminal and tilt-base support posts are aligned while you push them together, as shown in Figure 1. Do not push the plastic teeth of the tilt-base support post against the tip of the terminal support post.

3. Insert the tilt-base support post into the grooved channel on the terminal support post, as shown in Figure 2-3. Firmly push the two together until the axles on the base fit into the semi-circular depressions on the bottom of the VDU.

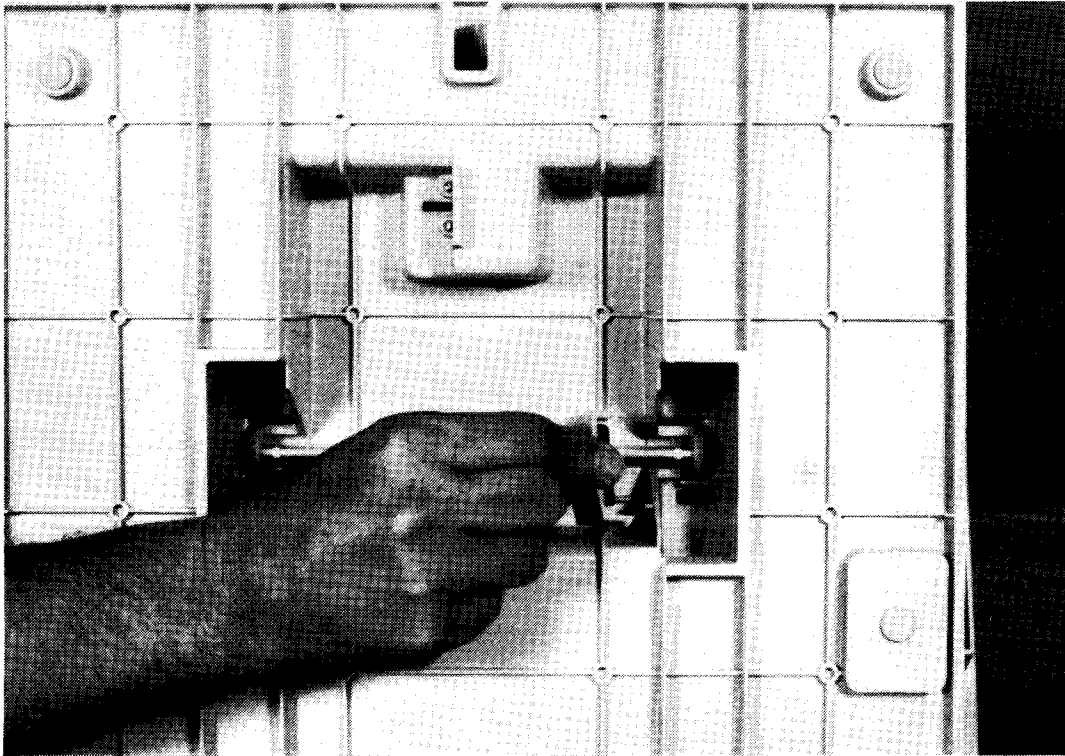

2229228-6

Figure 2-4. Securing the Model 931 VDT Tilt-Base Assembly

4. Place a retaining clamp over one axle. Snap the clamp legs into slots on each side of the axle. Repeat this step for the other axle.

Installation

To adjust the VDU to the desired viewing angle, securely grasp the sides of the unit with both hands and tilt it to the desired angle. The VDU remains at the selected angle after each adjustment.

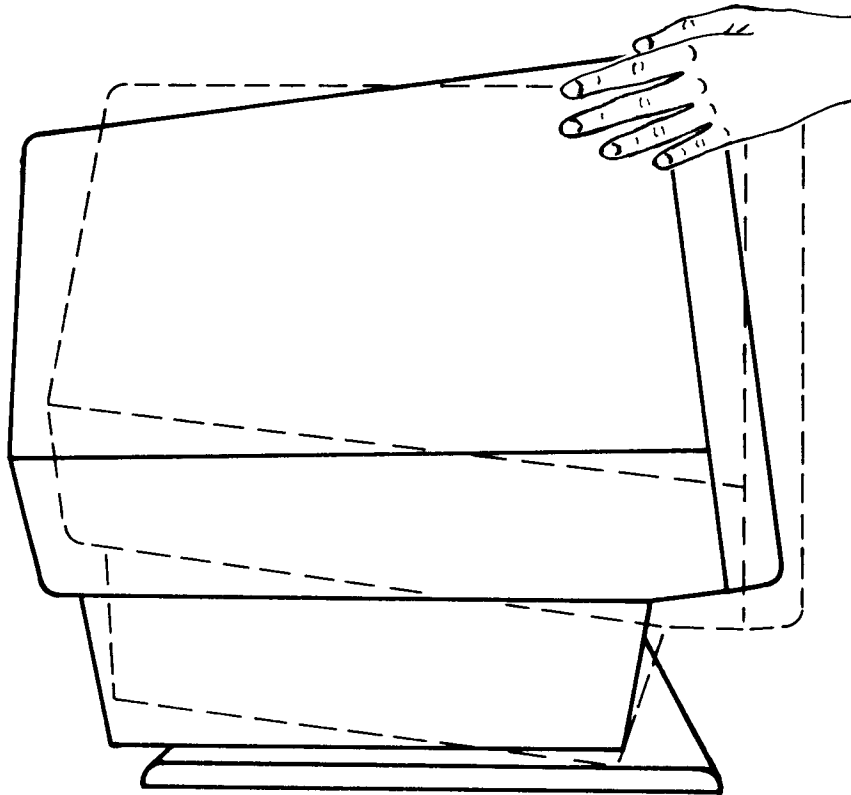
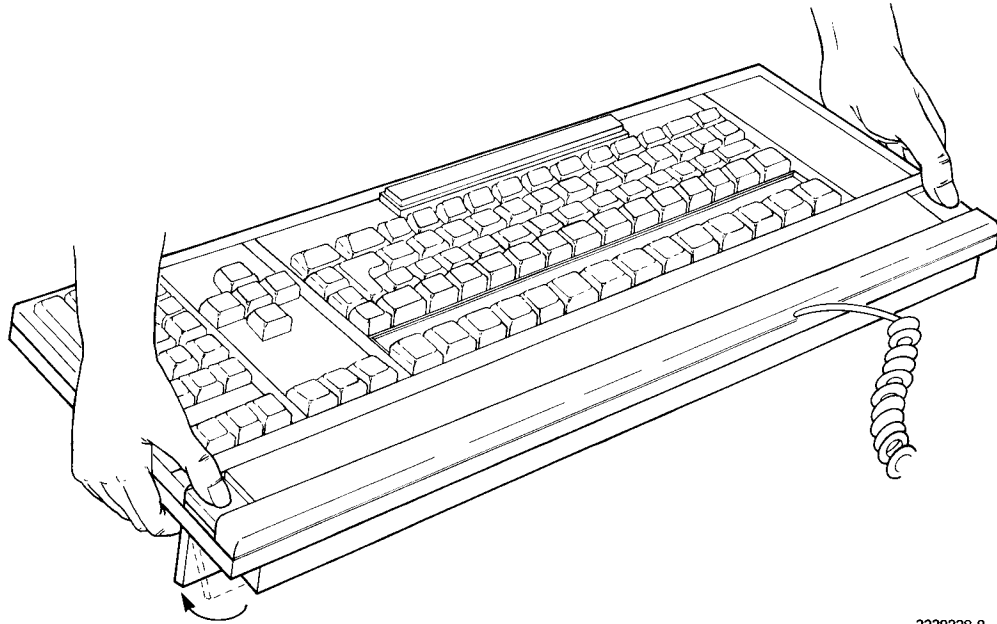

Figure 2-5. Installed Tilt-Base Assembly

2229228-7



2229228-8

Figure 2-6. Keyboard Angle Adjustment

2.4.2 Keyboard Angle Adjustment

The Model 931 VDT keyboard has a retractable, adjustable support running the length of the keyboard and located beneath its top edge. This support allows the operator to tilt the keyboard to a desired operating angle on a table surface or, with the support retracted, to lay it flat.

The keyboard is shipped with the support fully retracted. To extend the support, simultaneously press the tabs located on the outside edges of the keyboard, as shown in Figure 2-6. The support is released and may be hand-adjusted.

2.4.3 Back Panel of the Display Unit

Figure 2-7 is a view of the lower back panel of the Model 931 VDU. It shows the fiber-optics port, communications port, auxiliary port, voltage requirement label, fuse housing, ac power cord receptacle, and keyboard cable receptacle. All cable connections to the Model 931 VDT are made here. Figure 2-7 will help you to become familiar with cable port locations before you connect the terminal to the host system.

The fuse housing contains the power fuse. Fuse removal, inspection, and replacement procedures are described in Section 7, "Diagnostics."

CAUTION

Set the power switch to 0 (OFF). Disconnect the power cord from the wall outlet before connecting or disconnecting any cables to or from the Model 931 VDT.

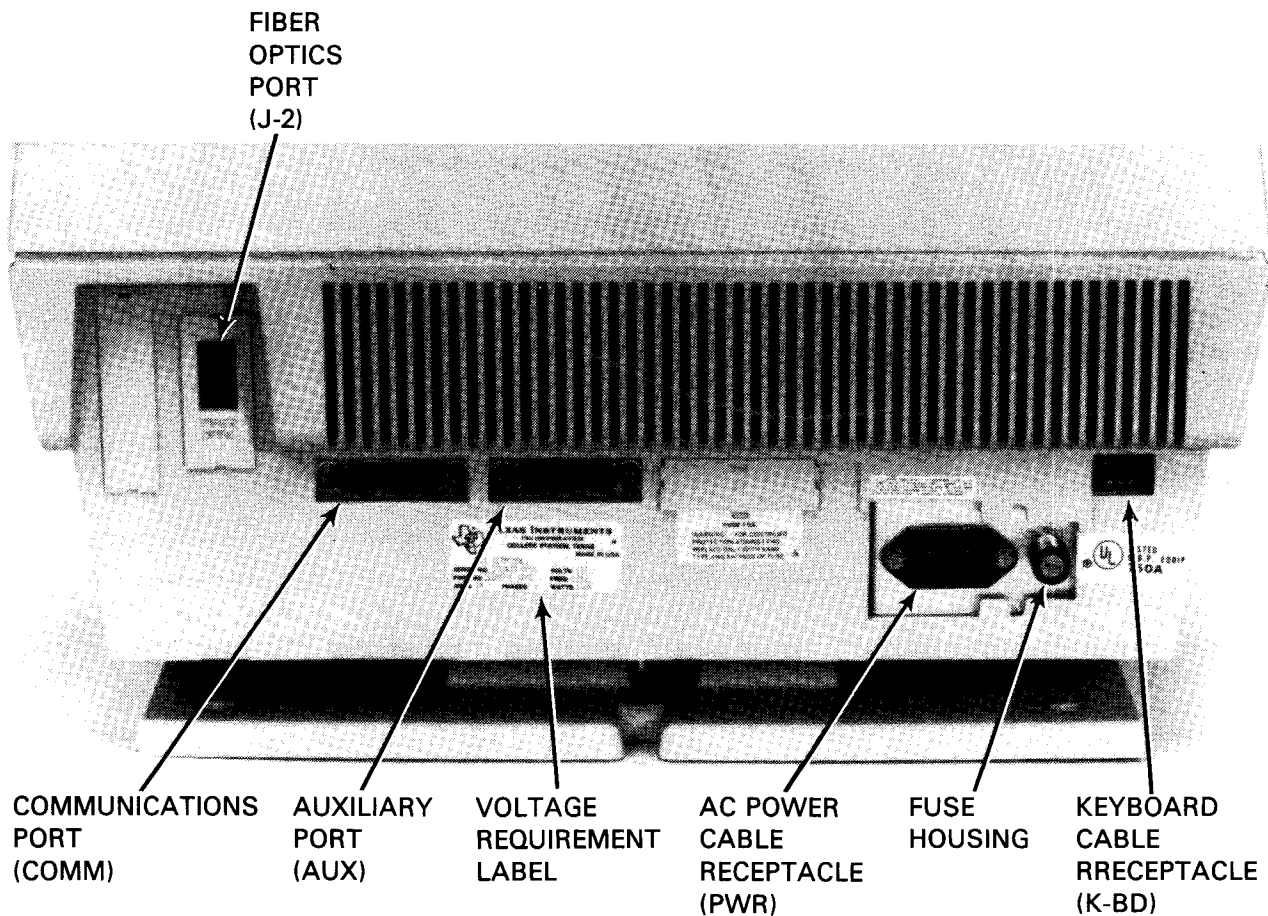

2229228-9

Figure 2-7. Lower Back Panel of the Model 931 VDT

2.4.4 Connecting the Keyboard with the VDU

Align the keyboard cable connector with the keyboard cable receptacle and insert the connector until it snaps into place.

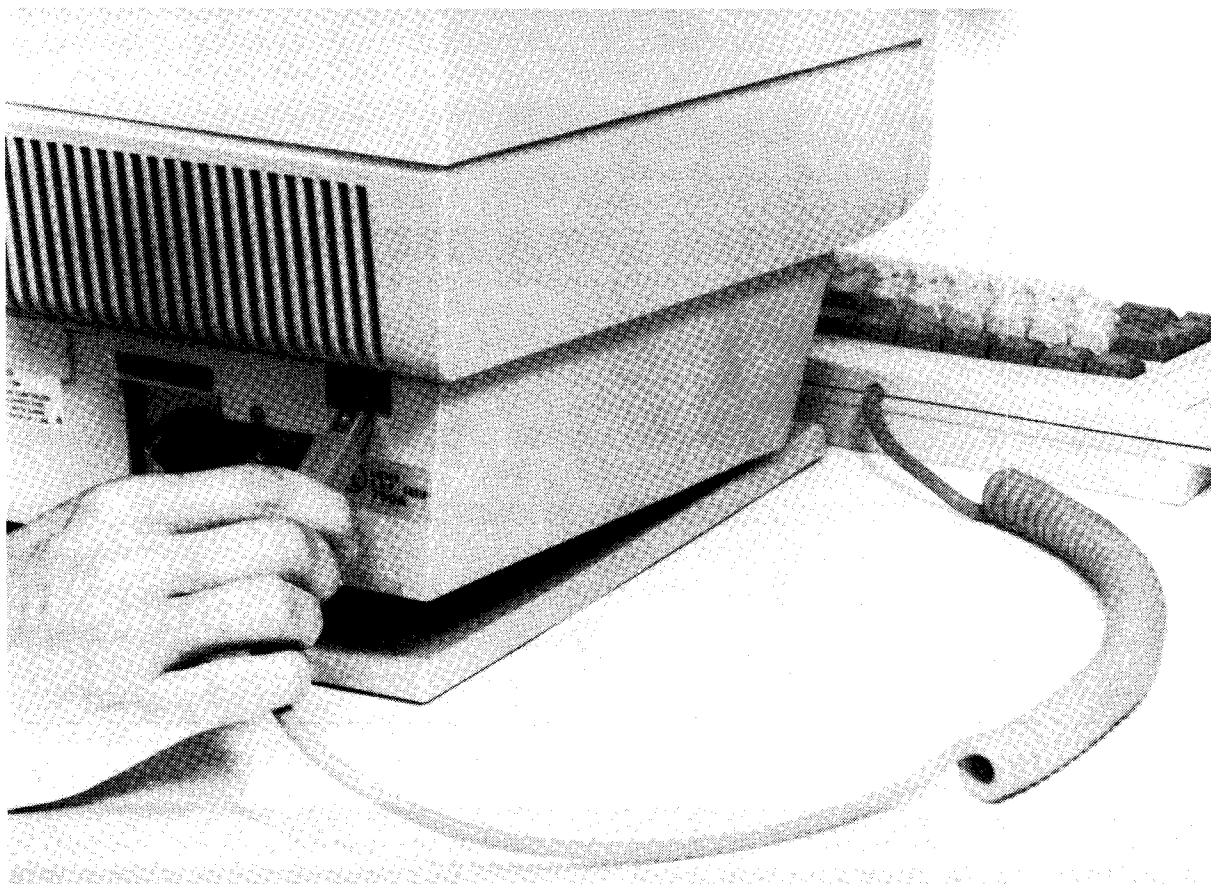

Figure 2-8. Keyboard Cable Connection

2.5 INTERFACING THE MODEL 931 VDT WITH A HOST COMPUTER

The Model 931 VDT is designed to interface with the Texas Instruments Small Business System 300, 600, or 800 computers. Each installation has specific cabling requirements. Refer to Section 3 to be sure you have the proper cables for your installation. If you are installing a terminal directly connected to the host, refer to paragraph 3.3 for cabling requirements. If your terminal is to be remotely connected to the host, refer to paragraph 3.4 for cabling information. When you have verified cabling requirements, return to this point and proceed with the installation. Skip instructions that do not apply to your installation.

2.5.1 Connecting the Model 931 VDT Directly to a Host Computer

Where the terminal and host are separated by no more than 15 m (50 ft), data is transmitted over an EIA RS-232-C communications cable.

If an EIA communications cable is provided with your system, install it on the terminal as follows:

1. Be sure the cable and Communications Interface (CI) part numbers are compatible with the installation (see Section 3).
2. Set the ac power switch labelled 1/0 on the front of the terminal to 0 (OFF) and make sure the power cord is not connected to the wall outlet.
3. Insert the 25-pin EIA communications cable connector into the port labelled COMM, as shown in Figure 2-9.

NOTE

Refer to Texas Instruments EIA Distance Policy Statement (TI Part No. 2303098) for information regarding speed/distance limitations of EIA cable installations.

4. With a small, flat-bladed screwdriver, tighten the locking screw on both sides of the connector.
5. Connect the other end of the EIA communications cable to the host computer.

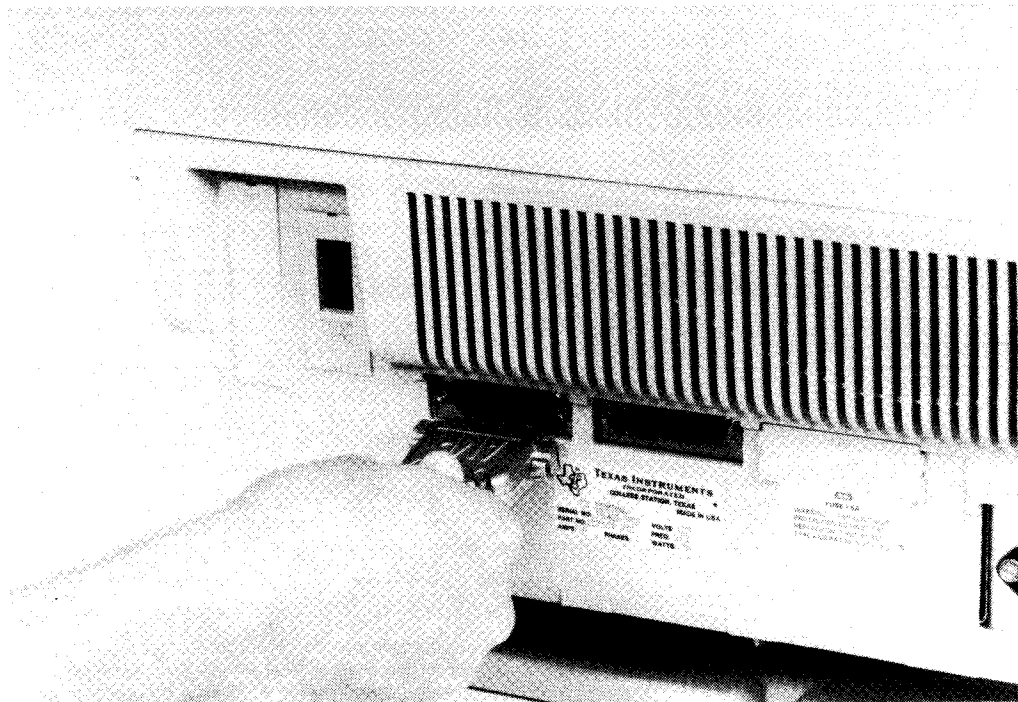

2229228-10

Figure 2-9. EIA Communications Cable Connection

Follow these directions to attach the EIA cable to the host CI. Refer to the appropriate communications interface manual (see list in Section 3.3) for details.

1. Route the cable to the host, using standard cabling practices. Route the cable through the appropriate opening in the cabinet and along the inside of the computer casing to the interface board.
2. Attach the plug labeled P1 to the appropriate connector on the CI (see Tables 3-1, 3-2, and 3-3). Be sure the cable is routed to the rear of the computer. For applications of cable installations for Business Systems 600 and 800, follow these directions also.
3. Secure the cable in one of the cable clamps located on the chassis. Using cable ties, secure the cable to the appropriate cabinet structures.
4. Make sure the cable does not interfere with other devices inside the system cabinet.

2.5.2 Fiber-Optics Cable

A fiber-optics interface is used when the terminal is to be directly connected to the host computer but separated from it by a distance greater than 15 m (50 ft) and not more than 1000 m (3280 ft).

Install the fiber-optics cable as follows:

1. Set the terminal power switch to 0 (OFF), and make sure the power cord is disconnected from the wall outlet.
2. Insert the two-jack fiber-optics cable connector (P2) into the fiber-optics port as shown in Figure 2-10.
3. Connect the other end of the fiber-optics cable to the host computer interface CI404 (see Table 3-1 and Section 3.3 for the appropriate manual).

Observe these precautions when handling a fiber-optics cable:

- Do not bend the fiber-optics cable. Avoid laying the cable around sharp corners, under office furniture, or in areas having chairs with casters.
- When the cable is not in use, seal both ends with the caps provided. Make sure no foreign particles (such as sand or grit) are on the contact edges of the cable.
- To clean the contacts, use a clean cloth dampened with water. Do not use alcohol.

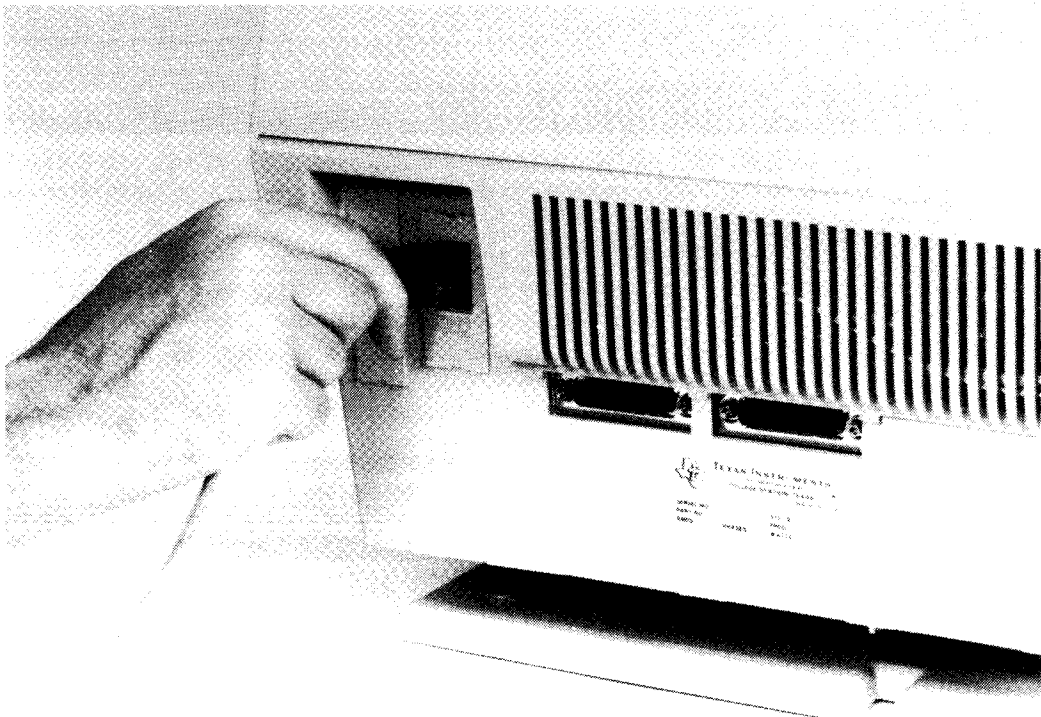

2229228-11

Figure 2-10. Fiber-Optics Cable Connection

2.5.3 Connecting a Modem to the Terminal

Remote connections between host and terminal require a modem connected to the terminal and a modem connected to the host. Follow these instructions to connect a modem to the Model 931 VDT:

1. Verify that the cable and interface are compatible (see Section 3).
2. Insert the 25-pin EIA communications cable connector into the Model 931 VDT port labelled COMM as shown in Figure 2-9.
3. With a small, flat-bladed screwdriver, tighten the cable-locking screw on each side of the connector.
4. Connect the other end of the cable to the EIA connector on the modem. To locate the EIA connector, refer to the installation and operating instructions supplied by the modem vendor.

2.5.4 Modem Settings

Refer to Section 3 for modem settings. Make adjustments where appropriate. Then, conclude installation by connecting peripheral equipment using your modem installation guide.

2.5.5 Connecting the Model 931 VDT to a Printer

The following Texas Instruments printers can be attached to the Model 931 VDT: Models 810, 850, and 855. In all cases, the P1 connector of the 4 m (13.12 ft) peripheral cable (TI Part No. 2230504-0001) is connected to the AUX-1 port of the VDT. Cable connector P2 attaches to the EIA connector of the printer.

When a printer is to be installed with the 931, set it up according to instructions shipped with the printer.

Use the following procedure to connect a printer with the Model 931 VDT:

1. Set the power switches on the printer and the VDT to 0 (OFF). Make sure the power cord is disconnected from the wall outlet.
2. Insert the 25-pin EIA auxiliary output cable connector into the Model 931 VDT port labelled AUX-1, as shown in Figure 2-11.
3. With a small, flat-bladed screwdriver, tighten the locking screw on both sides of the connector.
4. Attach the opposite end of the EIA auxiliary output cable to the printer or other device according to the instructions provided with that equipment.
5. Initiate the printer self-test according to the instructions in the printer installation and operation manual.

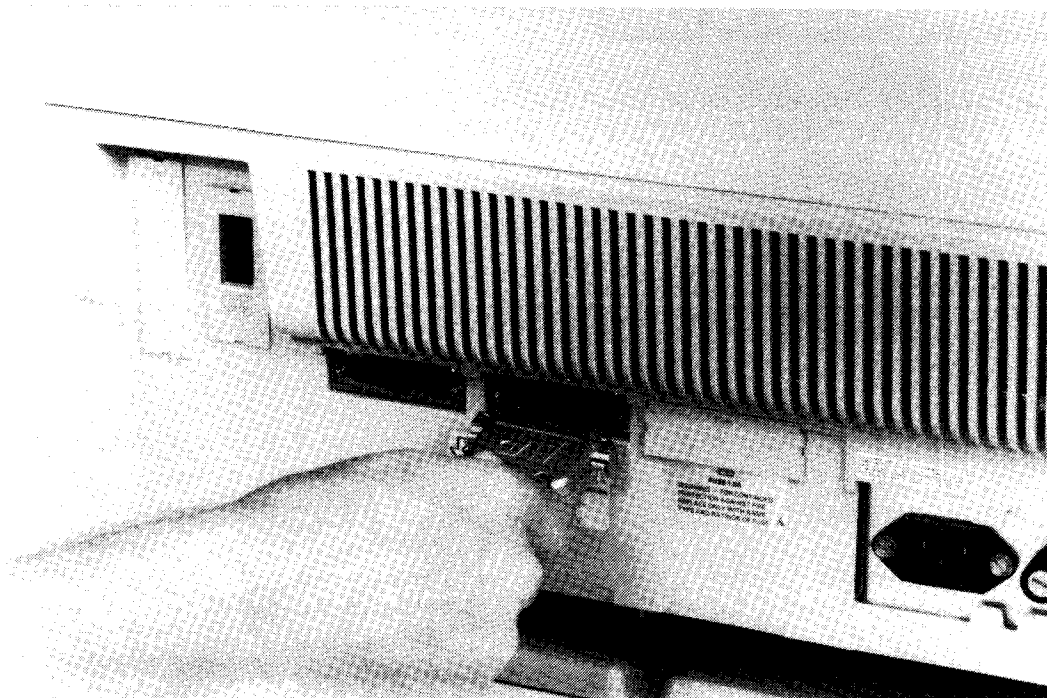

2229228-12

Figure 2-11. EIA Auxiliary Output Cable Connection

2.5.6 Extension Cables

For some applications, interface extension cables are necessary or desirable. If you require an extension cable, refer to Section 3 to select the correct one. Then return to Section 2 to complete installation of the terminal.

2.5.7 AC Check

Figure 2-12 shows a standard US ac electric wall outlet. The National Electrical Code requires that the wiring be hot on the right side of the outlet, neutral on the left side, and grounded at the round bottom connector. For US installations, the power supply at the outlet must meet voltage, grounding, and resistance specifications established by the National Electrical Manufacturers Association (NEMA) and by local electrical codes (local codes supersede NEMA codes).

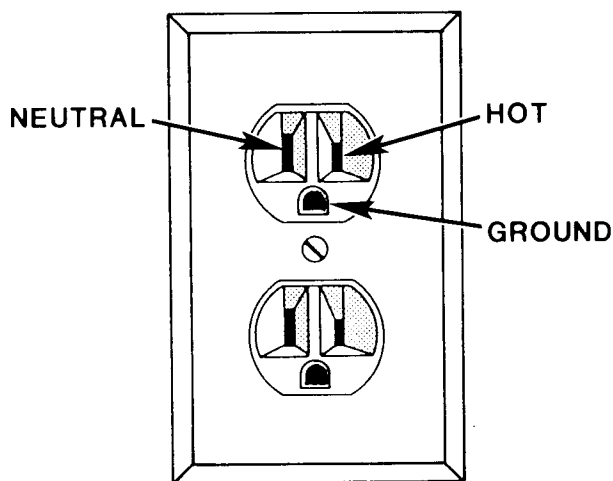

2229228-13

Figure 2-12. Three Wire, Earth-Grounded Electric Wall Outlet

CAUTION

Before connecting the ac power cord, have the electric outlet checked by a qualified electrician.

2.5.8 AC Power Cord Connection

WARNING

Be sure the ac wall outlet voltage matches the voltage listed on the back panel of the display unit. Also, be sure the wall outlet is a three wire, earth-grounded unit. Injury to the operator or damage to the terminal can result from improper connection.

The ac power cord connects the terminal to an electric wall outlet. Do not connect any other electrical equipment (typewriters, adding machines, copiers, pencil sharpeners, lighting fixtures, etc.) to the same circuit.

Connect the ac power cord as follows:

1. Set the terminal power switch to 0 (OFF).
2. Insert the ac power cord connector into the ac power cord receptacle on the back panel of the display unit (Figure 2-13).
3. Insert the ac power cord plug into the wall outlet.

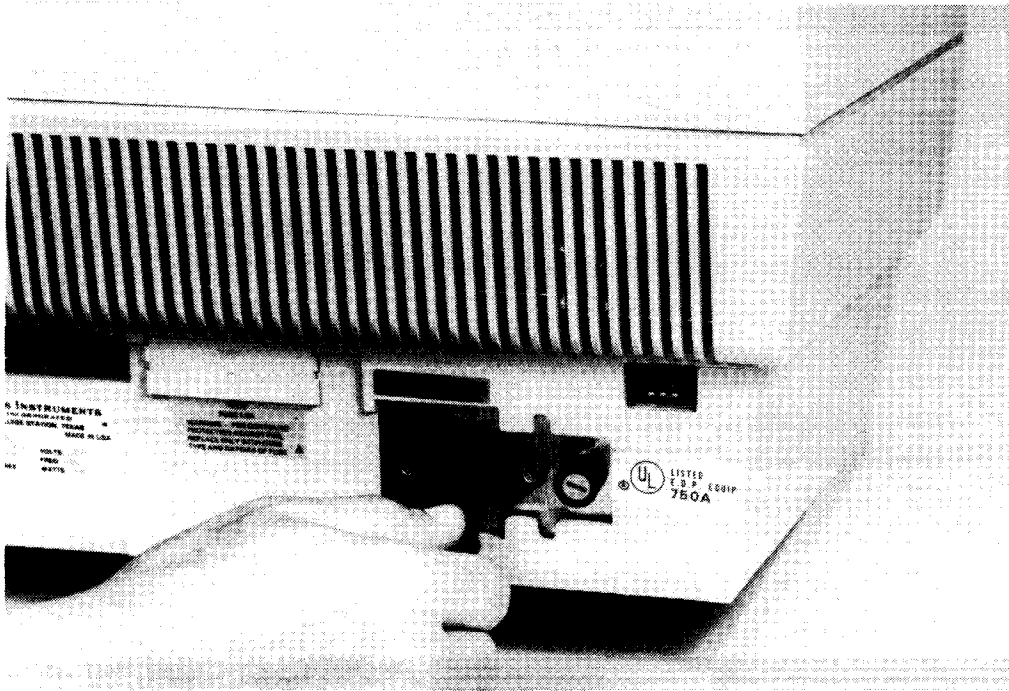

2229228-14

Figure 2-13. AC Power Cord Connection

2.6 POWER-UP AND CHECKOUT

At power-up, the terminal performs a warmup and self-test sequence that prepares it for operation. When the terminal is powered up but not in use, a standby sequence is automatically initiated.

2.6.1 Warmup and Self-Test Sequence

1. Press the 1 (ON) segment of the switch on the front right of the VDU.
2. Allow 10 seconds for the self-test. The terminal sounds an audible tone when the test is complete.
3. Allow 30 seconds for the screen to warm up.

NOTE

Since screen warmup takes longer than self-test, no self-test message appears on the screen of a functional terminal. If the Model 931 VDT hardware fails the self-test, the message "SELF TEST FAILED" appears on the left side of the status line, followed by an error message. To identify the message, refer to Section 7. *Do not* attempt to operate the terminal until the problem is corrected, and the self-test completes successfully.

4. When warmup is complete, a status line display appears on line 25 of the VDU. The cursor is in the top left corner, ready for data entry.

The 931 VDT powers up in the online mode. In most hard-wired and fiber-optics applications, communication is established automatically and the Comm port message on the status line is Rdy (ready). For remote applications using modems, the host must be called and modem communication procedures must be used. When the modem link is established, the status line shows Rdy. The terminal now needs to be configured for systems operation. Proceed to Section 4, but first read the following paragraph.

2.6.2 Standby

1. When the status line has been displayed, the Model 931 VDT awaits data entry from the keyboard or from the host computer. If data is not received within 15 minutes, the screen automatically blanks but retains the displayed information in memory.
2. Upon receiving data, the terminal immediately redisplay the saved information with no warmup lapse.
3. Press any key to reactivate the screen and call up stored data.

Communications

3.1 INTRODUCTION

This section contains reference information for connecting the Model 931 VDT to the Texas Instruments Small Business System 300, 600, or 800 series computers. Use the information to ensure that correct cables and modem settings are selected. Then refer to Section 2 for full installation procedures. Topics in Section 3 include:

- Types of installations
- Local configurations
- Remote configurations
- Extension cables
- Recommended modem settings

3.2 TYPES OF INSTALLATIONS

The Model 931 VDT can be configured for both direct and remote (modem) operation. Figure 3-1 shows these configurations.

A printer can be attached to the Model 931 VDT AUX-1 port connector in all installations. Online, the host computer has access to the printer and can use it while the terminal is engaged in an unrelated task.

3.3 DIRECT CONFIGURATIONS

For direct configurations, direct connect EIA RS-232-C cables or fiber-optics cables connect the terminal and host. Applications and host system architecture determine the appropriate communications interfaces and cables for the installation. Tables 3-1, 3-2, and 3-3 list the communications interfaces, cables, and connections that link various Business System computers with the Model 931 VDT in direct configurations. Use the tables to determine whether or not you have the correct cables for your system.

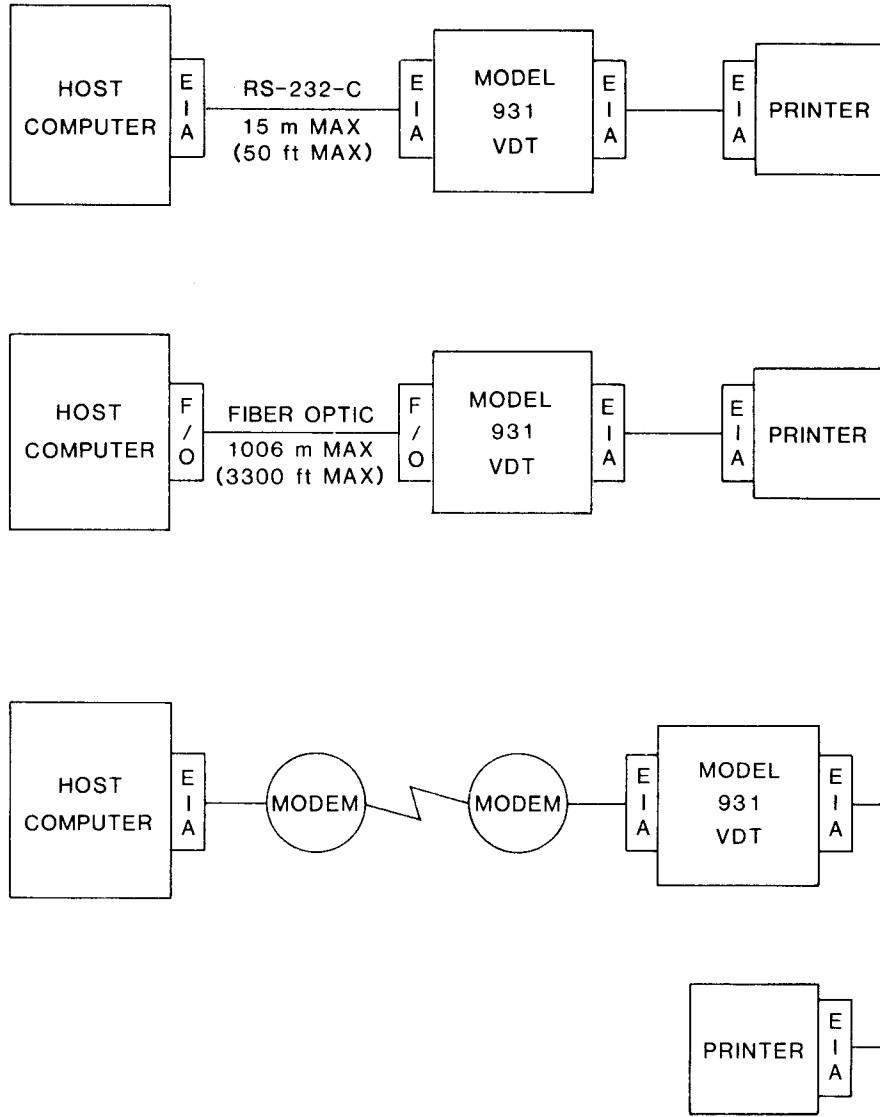

2229228-15

Figure 3-1. Direct and Remote Model 931 VDT/Host Configurations

Table 3-1. Direct Connect Interfaces, 990/10A Computer to Model 931 VDT

Communications Interface	Cable	Cable Connections
Model: 990/10A TI Part No.: 2275975-0002 2275975-0004	EIA RS-232-C TI Part No.: 2303077-0001	Connect P2 (25 pin) of the EIA cable to the 931 VDT Comm port.
	Length: 9.2 m (30.18 ft)	Connect P1 (18 pin) of the EIA cable to the 990/10A EIA connector.

Return to paragraph 2.5.1 and proceed with the installation.

Table 3-2. Direct Connect Interfaces, S600 and S800 Computers to the Model 931 VDT

Communications Interface	Cable	Cable Connections
Model: CI402 TI Part No.: 2303105-0001	EIA RS-232-C TI Part No.: 2303077-0001	Connect P2 of the cable to the 931 VDT COMM port.
Two Channel Interface	Length: 9.2 m (30.18 ft)	Connect P1 of cable to P2 or P3 on the CI402. The interface supports two terminals or peripherals.
Model: CI403 TI Part No.: 2230350-0001	EIA RS-232-C TI Part No.: 2303077-0001	Connect P2 of cable to the 931 VDT COMM port.
Four Channel Interface	Length: 9.2 m (30.18 ft)	Connect P1 of cable to P3, P4, P5, or P6 on the CI403. The interface supports four terminals or peripherals.
Model: CI404 TI Part No.: 2230360-0001	Fiber Optics TI Part No.: 2233200-0001	Connect P2 of cable to the 931 VDT F/O.
Four Channel Interface	Length: 15 m (49.20 ft)	Connect P1 of cable to P3, P4, P5, or P6 on the CI404. The interface supports four terminals or peripherals.

Return to paragraph 2.5.1 and proceed with the installation.

Table 3-3. Direct Connect Interfaces, S300 Computer to Model 931 VDT

Communications Interface	Cable	Cable Connections
Model: CI421 TI Kit No.: 2532823-0001	EIA RS-232-C TI Part No.: 2230504-0002	Connect P2 of cable to the 931 VDT COMM port.
Two Channel Interface	Length: 8 m (26.24 ft)	Connect P1 of cable to S300 COMM or AUX-2 ports
		The interface supports terminals or peripherals.
Model: CI422 TI Part No.: 2532860-0001	EIA RS-232-C TI Part No.: 2230504-0002	Connect P2 of cable to the 931 VDT COMM port.
Four Channel Interface	Length: 8 m (26.24 ft)	Connect P1 of cable to J1, J2, J3, or J4 on the S300 four to one cable.
		The interface supports four terminals or peripherals.

Return to paragraph 2.5.1 and proceed with the installation.

The listed supporting interfaces render the communications software of the host computer compatible with 931 protocol. Two-channel and four-channel EIA interfaces are available for all Business System computers. Your choice depends upon the number of terminal and peripheral units to be supported in the application.

Note that a fiber-optics (F/O) interface is available for direct connect applications using the 600 and 800 series computers. It is appropriate for local applications in which the terminal and host are separated by distances greater than 15 m (50 ft) but not more than 1000 m (3280.83 ft)

F/O capability is available for all systems. An external converter module (TI Part No. 2233210-0001) is used for Fiber Optic installations in which the Model 931 VDT or the host computer is not configured for fiber optic cables.

Installation guides for communications interfaces are:

Title	Part Number
<i>Two-Channel Communication Kit, Installation Guide</i>	2533313-9701
<i>Four-Channel Communication Kit, Installation Guide</i>	2230312-9701
<i>CI402 Installation and Operation</i>	2263895-9701
<i>CI403/404 Installation and Operation</i>	2263897-9701

Follow the appropriate procedures to install the communications interface, and return to Section 2.

3.4 REMOTE CONFIGURATIONS

When direct connection is not practical or desirable (for example, when terminal and host are separated by miles), a modem can be used. A modem provides an interface between the Model 931 VDT and the telephone line. Modems tested and found acceptable for use in remote configurations are the Texas Instruments Model 451 and the Bell 212A.

Two cables are necessary for each installation (see Tables 3-4, 3-5, and 3-6). One connects the computer and the host modem. The other connects the 931 VDT with the terminal modem. Use the tables to determine whether or not you have the correct cables for your system and return to paragraph 2.5.3 for installation instructions.

In all remote applications, the 3 m (9.84 ft) cable (TI Part No. 2532883-0001) is used to connect the terminal modem with the Model 931 VDT. The P2 connector attaches to the Comm port on the terminal. Connector P1 attaches to the modem.

Table 3-4 lists the interfaces, cables, and connections for connecting a host modem with a Texas Instruments computer of the 600 and 800 series.

Table 3-4. Remote Interfacing, S600 and S800 Computers to Modem

Supporting Interface	Cable	Cable Connections
Model: CI402 TI Part No.: 2303105-0001	EIA RS-232-C TI Part No.: 2303070-0003	Connect P2 of cable to the modem EIA connector.
Two Channel Interface	Length: 3 m (9.84 ft)	Connect P1 of cable to P2 on the CI402. P3 on CI402 can also be used to connect the cable.
Model: CI403 TI Part No.: 2230350-0001	EIA RS-232-C TI Part No.: 2303070-0003	Connect P2 of cable to the modem EIA connector.
Four Channel Interface	Length: 3 m (9.84 ft)	Connect P1 of cable to P3 on the CI403. P4, P5, and P6 on the CI403 can also be used to connect the cable.

Table 3-5 lists the interfaces, cables and connections for connecting a host modem with a Texas Instruments Business System 300 Computer.

Table 3-5. S300 Computer to Modem, Communications Interfaces

Supporting Interface	Cable	Cable Connections
Model: CI421 TI Kit No.: 2532823-0001	EIA RS-232-C TI Part No.: 2532883-0001	Connect P2 of cable to modem EIA connector.
Two Channel Interface	Length: 3 m (9.84 ft)	Connect P1 of cable to COMM. P1 of cable can also be attached to AUX-2 of two-channel CI.
Model: CI422 TI Part No.: 2532860-0001	EIA RS-232-C TI Part No.: 2532883-0001	Connect P2 of cable to modem EIA connector.
Four Channel Interface	Length: 3 m (9.84 ft)	Connect P1 of cable to J1 on the four to one cable adaptor. J2, J3, and J4 can also be used to connect P1 of cable.

3.5 EXTENSION CABLES

When planning the placement of the 931 at the installation site, consider the lengths of the cable(s). Be sure to allow space for the cable between the communications interface (located in the host chassis) and the exit point from the Texas Instruments host computer system. Extension cables are available for direct configurations of the Model 931 VDT.

The EIA terminal extension cables are available in two lengths.

Length	TI Part No.
15 m (49.21 ft)	2303071-0002
60 m (196.85 ft)	2303071-0004

Fiber optic extension cables are available in three lengths.

Length	TI Part No.
60 m (196.85 ft)	2233201-0002
150 m (492.13 ft)	2233201-0003
300 m (984.25 ft)	2233201-0004

Refer to Table 3-6 to determine whether or not you have the proper extension cable for your system and how it is attached. Return to paragraph 2.5 to complete the installation.

Table 3-6. Extension Cables

Texas Instruments Computer Series	TI Part No.		Instruction
	Host Cable	Extension Cable	
600 800	2303077	2303071	Connect P1 of extension to P2 on 2303077-0001. Connect P2 of extension to 931 VDT Comm port.
300	2230504	2303071	Connect P1 of extension to P2 on 2230504-0002. Connect P2 of extension to 931 VDT Comm port.
600 800	2233200	2233201	Connect P1 of extension to P2 on 2233200-0001. Connect P2 of extension to 931 VDT fiber optics port.

3.6 MODEM SETTINGS

Communications settings for the Texas Instruments Model 451 Modem are set at the factory. Table 3-7 lists the recommended settings for the Bell 212A Modem. Use this table if it is appropriate for your installation. Then, continue the installation procedures described in paragraph 2.5.9.

Table 3-7. Recommended Settings for the Bell 212A Modem

Modem Option	Recommended Settings
Tip Ring Make BUSY	Out — E
CC Indication for Analog Loop	On — ZF
CN Circuit	Out — YF
Transmitter Timing	Internal — YC
1200 Baud Operation	Async/start-stop — YG
Character Length	10-bit — YJ
Receiver Respond to Digital Loop	Off — YL
Loss of Carrier Disconnect	In — S
Receive Space Disconnect	In — V
CB and CF Indications	Common — A
Send Space Disconnect	In — T
Automatic Answer	In — ZH
Answer Mode Indication, CE	Off — W
Speed Mode	Dual — YP
Interface Speed Indication, CI	In — YQ
Signal Ground to Frame Connection	In — Q
Speed Control	Interface — XJ

Configuration

4.1 INTRODUCTION

This section provides instructions for setting communications parameters at the terminal. These parameters affect the operation of the terminal in a systems environment.

Before data can be transmitted or received by the Model 931 VDT, the terminal must be configured to communicate with the host system. This section discusses how to configure all necessary parameters at the terminal.

4.2 PROGRAMMER CONFIGURATION MODE

For purposes of configuring the terminal, we are concerned only with configuration settings for the Comm port (through which the terminal and host computer communicate) and the Aux port (to which a printer can be attached). Configurable parameters for both ports are set when the terminal is configured. Selected settings are stored in nonvolatile memory and remain in effect until the systems manager enters fresh configurations.

To alter configuration parameters, the programmer enters the configuration mode. This may be done online or offline. If the programmer enters the configuration mode when the terminal is online, host communications are suspended until the configuration mode is exited.

If a local printer is attached and properly configured, pressing the **PRINT** key at any time while you are in the configuration mode will cause the terminal to print all configuration parameters.

To enter the configuration mode, simultaneously press the **ALT**, **SHIFT**, and **BACKSPACE** keys. The Config menu appears on the status line as follows:

```
Config: Comm  Aux  Dsply  Keybd  Diag
```

This menu allows the programmer to select the set of parameters (Comm port, Aux port, Display, Keyboard protection, or Diagnostics) to be configured. One entry in the menu is always underscored and highlighted. This selection is the parameter to be configured. Use the following routine to select the parameters you want to configure.

1. To move the underscore and highlight to the right, press the **TAB** key or **RIGHT ARROW** key (cursor group). When the underscore is placed beneath the last (right-hand) entry, pressing the **TAB** or **RIGHT ARROW** key returns the underscore to the first (left-hand) selection. (Underscore and highlight wrap right to left.)

2. To move the underscore and highlight to the left, press the **SHIFT** and **TAB** keys at the same time or press the **LEFT ARROW** key. When the underscore is beneath the first (left-hand) entry, pressing the **SHIFT** and **TAB** keys (or the **LEFT ARROW** key) moves the underscore to the last (right) entry. (Underscore and highlight wrap left to right.)
3. Press the **RETURN** key or **DOWN ARROW** key to display the first menu for the parameter to be configured.
4. Parameter changes are typamatic. To cycle through the menu automatically, press and hold any of the keys that move the underscore and the highlight. Release the keys quickly when you reach the desired option.

NOTE

Exit the configuration mode at any time by simultaneously pressing the **ALT**, **SHIFT**, and **BACKSPACE** keys.

4.3 COMMUNICATIONS (COMM) PORT

The first step in configuring the Model 931 VDT is to set Comm port parameters to suit systems protocol.

4.3.1 Configuring Comm Port Parameters

Refer to the host system manual to determine communications parameters. Then follow these procedures to configure them.

1. Select the Comm menu from the first Config menu by placing the underscore beneath Comm, which now becomes highlighted. (The **RIGHT ARROW** key moves underscore and highlight to the right; the **LEFT ARROW** key moves it to the left.)
2. Press the **RETURN** key or the **DOWN ARROW** key to select the first menu for the Comm port.
3. Press the **TAB** key or **RIGHT ARROW** key to underscore and highlight an entry to the right. Press the **SHIFT** key and **TAB** key simultaneously (or the **LEFT ARROW** key) to underscore and highlight an entry to the left.
4. Parameter changes are typamatic. To move through configuration options automatically, press and hold a key that moves the underscore (highlight). Release the key quickly when you reach the desired option.
5. Press the **RETURN** key or the **DOWN ARROW** key to set your choice for the displayed selection and move the display to the next line of the menu. The highlighted parameter for each menu is stored as the next menu is selected.
6. Choose Comm port parameters in a similar manner by stepping through Comm menus line by line.

7. Keep cycling through the Comm port selections until all parameters are properly configured. You can return to the master Config menu at any time by pressing the **UP ARROW** key.
8. Exit the configuration mode at any time by simultaneously pressing the **ALT** key, the **SHIFT** key, and the **BACKSPACE** key.

4.3.2 Comm Port Menus

Comm port menus are presented in the order they are encountered. Each menu line is listed exactly as it appears on the screen. The list is followed by a description of the options to be configured. The first Comm port menu line is:

Comm Speed: 300 600 1200 2400 4800 9600 19200

This selection determines the speed or baud rate at which the Model 931 VDT communicates with the host computer. If modems are being used, the baud rate of the modem should be taken into account (as well as the baud rate of the host computer).

NOTE

Refer to Texas Instruments EIA Distance Policy Statement (TI Part No. 2303098) for information regarding speed/distance limitations of EIA cable installations.

Configure Comm Speed and proceed to the next Comm menu.

Comm Parity: Even Odd Mark Space

This setting determines the value of the parity bit for data transmitted to the host. *Even* and *Odd* select even and odd parity, respectively. *Mark* causes the parity bit to be set always to 1. *Space* always causes the parity bit to be set to 0.

Comm Receive Parity Check: On Off

The *On* setting causes the terminal to test the parity bit of all received data. If the parity bit is in error, the data character received is replaced with a SUB (1A) character. Characters received in error cause the parity error counter to be incremented (see Read Status Command, Section 5).

This accuracy of received data check is applied only when the Comm Parity selection is *Even* or *Odd*.

Comm Protocol: FDPX FDPX-RC(Rdy = On) FDPX-RC(Rdy = Off)

FDPX selects an interface protocol suitable for use with full-duplex modems. The terminal will send a DC3 (hex 13) control character to the host when fewer than 128 character storage positions are available. A corresponding DC1 (hex 11) will be transmitted when more than 128 character storage positions are available.

Configuration

FDPX-RC(Rdy= On) is the same as *FDPX* except that Pin 11 (SRTS) of the EIA interface is set to OFF to indicate that fewer than 128 character storage positions are available. Pin 11 is set to ON (ready) to indicate that more than 128 character storage positions are available.

FDPX-RC(Rdy= Off) is the same as *FDPX* except that Pin 11 (SRTS) of the EIA interface is set to ON to indicate that fewer than 128 character storage positions are available. Pin 11 is set to OFF (ready) to indicate that more than 128 character storage positions are available.

Comm Transmit Block Size: 01H

This command and the next one cause the terminal to pace the transmission of data to the host by defining the maximum size of the block transmitted and the minimum delay time between transmissions. The smallest transmissible unit is a single character; the largest is hex FF (255). Each unit of time represents 10 ms of delay. A delay time selection of *00H* disables this option.

These selections are incremented by pressing the **RIGHT ARROW** key and are decremented by pressing the **LEFT ARROW** key.

Comm Transmit Block Delay: 01H

Comm Port: EIA Internal

EIA selects the Comm RS-232-C connector as the host interface. Internal selects an installed communications option (for example, fiber optics) as the host interface. Both connectors can be cabled, but only the selected option is activated. The terminal senses whether or not an option board is installed at initialization. If no option board is present, the RS-232-C connector is activated even if *Internal* is selected.

Comm Receive DC1/DC3: On Off

Set *On* and the terminal interprets DC3 (hex 13) to mean that the host is unable to accept data. Data to be transmitted to the host are queued and the status line displays "Busy" until DC1 (hex 11) is received.

Set *Off* and the terminal ignores received DC1 and DC3 characters.

4.4 AUXILIARY (AUX) OUTPUT PORT

The Aux port is an output port only. It is provided to attach a printer or other peripheral device using a standard 25-pin EIA connector.

4.4.1 Configuring Aux Port Parameters

Follow this sequence to configure the Aux port parameters:

1. Refer to the printer installation and operation manual for the proper Aux port parameter settings.

2. Select the Aux port menu from the first Config menu. Press the **TAB** key or **RIGHT ARROW** key to move the underscore and highlight to the right. Press the **SHIFT** key and **TAB** key simultaneously (or the **LEFT ARROW** cursor key) to move the underscore and highlight to the left. Underscore (highlight) the Aux port menu selection.
3. Press the **RETURN** key or the **DOWN ARROW** key to bring the line of the Aux port menu to the status line of the screen.
4. Choose the Auxiliary output port parameters by stepping through Aux menus line by line.
5. Press the **TAB** key or **RIGHT ARROW** key to underscore and highlight an entry to the right. Press the **SHIFT** key and **TAB** key simultaneously (or the **LEFT ARROW** key) to underscore and highlight an entry to the left.
6. Parameter changes are typamatic. To move through configuration options automatically, press and hold a key that moves the underscore (highlight). Release the key quickly when you reach the desired option.
7. Press the **RETURN** key or the **DOWN ARROW** key to set your choice for the displayed selection and to move the display to the next line of the menu.
8. Press the **UP ARROW** key to set your choice for the displayed selection and to return the display to the previous line of the menu.
9. Press the **UP ARROW** key on the first line of the menu to return the display to the Config menu.
10. Press the **RETURN** key or **DOWN ARROW** key on the last line of the menu to record a selection for this line and to return the display to the first Aux menu.

NOTE

Exit the configuration mode by simultaneously pressing the **ALT**, **SHIFT**, and **BACKSPAC** keys. If a printer is attached to the terminal, you can print all configuration parameters at any time by pressing the **PRINT** key.

4.4.2 Aux Port Menus

Aux port menus are presented in the order they are encountered. Each menu line is listed exactly as it appears on the screen. The list is followed by a description of the options to be configured. The first Aux port menu line is:

Aux Enable: Yes No

Configuration

Set *Yes* to enable Model 931 VDT Aux port. Set *No*, and the terminal logically ignores an attached printer. Any data intended for the printer is discarded.

Aux Speed: 300 600 1200 2400 4800 9600

This option determines the speed (baud rate) at which the Model 931 VDT transmits data to the printer. Set Aux Speed to match the speed of the attached printer.

NOTE

Refer to Texas Instruments EIA Distance Policy Statement (TI Part No. 2303098) for information regarding speed/distance limitations of EIA cable installations.

Aux Parity: Even Odd

Select one option and be sure the printer is similarly configured.

Aux Protocol: FDPX FDPX-RC(Rdy = ON) FDPX-RC(Rdy = OFF)

Select *FDPX* to ignore the Busy/Ready status of printer. Select *FDPX-RC(Rdy = On)* to monitor Pin 12 of the terminal/printer interface: On = Ready, Off = Busy. Select *FDPX-RC(Rdy = Off)* for ON = Busy, OFF = Ready.

Aux Offline Data Abort: Yes No

Set *Yes*, and the terminal discards data intended for the Aux device when it is offline (Pin 6 [DSR] at the Model 931 Aux connector is Off). Set *No*, and the terminal queues data intended for the Aux device until it returns online. However, only one Write Data to Device request (132 characters maximum) is queued.

4.5 DISPLAY (DSPLY)

The next parameters to be configured are the cursor size, the video timer, and the display frequency.

4.5.1 Configuring Display Parameters

Follow these procedures to configure the display parameters.

1. Select the Dsply menu from the first Config menu by placing the underscore beneath Dsply, which now becomes highlighted. (The **RIGHT ARROW** key moves underscore and highlight to the right; the **LEFT ARROW** key moves it to the left.)
2. Press the **RETURN** key or the **DOWN ARROW** key to select the first menu.

3. Press the **TAB** key or **RIGHT ARROW** key to underscore and highlight an entry to the right. Press the **SHIFT** key and **TAB** key simultaneously (or the **LEFT ARROW** key) to underscore and highlight the entry to the left.
4. Parameter changes are typamatic. To move through configuration options automatically, press and hold a key that moves the underscore (highlight). Release the key quickly when you reach the desired option.
5. Press the **RETURN** key or the **DOWN ARROW** key to set your choice for the displayed selection and move the display to the next line of the menu. The highlighted parameter for each menu is stored as the next menu is selected.
6. Choose all display parameters in a similar manner by stepping through Dsply menus line by line.
7. Keep cycling through the selections until all parameters are properly configured. You can return to the master Config menu at any time by pressing the **UP ARROW** key.
8. Exit the configuration mode at any time by simultaneously pressing the **ALT** key, the **SHIFT** key, and the **BACKSPACE** key.

4.5.2 Display Menus

Cursor: Block Underline

This selection allows you to determine the type of cursor used. *Block* causes the cursor to occupy an entire 9x14 character cell. *Underline* causes the cursor to occupy only the bottom scan line of a character cell.

Video Timer: On Off

If *On* is selected, the terminal will blank the display after 15 minutes of inactivity. The display will be restored when data is received from the host or keyboard. This feature prolongs the life of the display. *Off* disables this feature.

Dsply Freq: 50 Hz 60 Hz

This selects the display refresh rate. 60 Hz provides the most pleasing display, and is the preferred choice for most installations, (including sites with 50 Hz power). In some installations, electromagnetic interference from nearby devices (printers, fluorescent lights, transformers, etc.) will cause the display to distort (swim). If the source of the interference cannot be isolated and removed, select the display frequency to match the AC line frequency.

4.6 PROTECTED KEYBOARD FUNCTIONS (KEYBD)

The Protected Keyboard Functions allow the user to inhibit the function of certain groups of keys.

4.6.1 Configuring Protected Keyboard Functions

Use the following procedures to configure the level of keyboard protection desired.

1. Select the Protected Keyboard menu from the first Config menu by placing the underscore beneath Keybd, which now becomes highlighted. (The **RIGHT ARROW** key moves the underscore and highlight to the right; the **LEFT ARROW** key moves it to the left.)
2. Press the **RETURN** key or the **DOWN ARROW** key to select the Protected Keyboard Functions menu.
3. Press the **RIGHT** or **LEFT ARROW** keys to underscore and highlight the desired function.
4. Press the **UP ARROW** key to select the chosen mode and to return to the master Config menu.

4.6.2 Protected Keyboard Menu

When selected, the menu should look as follows:

Protected Keyboard Functions: None CTRL ALT CTRL and ALT

This indicates that there is no protection, and the keys perform as described in Appendix C.

Protected Keyboard Functions: None CTRL ALT CTRL and ALT

Protected CTRL key mode protects the operator from some control keys which can cause unexpected results. The keys affected by this mode are listed in Table 4-1.

Table 4-1. Protected CTRL Key Functions

Key Sequence	Code Transmitted
CTRL N or SHIFT CTRL N (SO)	None
CTRL O or SHIFT CTRL O (SI)	None
CTRL S or SHIFT CTRL S (DC3)	None
CTRL [or SHIFT CTRL [(ESC)	None
ESC	ESC f

Protected Keyboard Functions: None CTRL ALT CTRL and ALT

Protected ALT key mode protects the operator from most **ALT** keys except the **BRK** key and the **DEL** key. The affected keys are listed in Table 4-2. All key sequences not listed in this table remain unchanged.

Table 4-2. Protected ALT key Functions

Old Key Sequence	New Key Sequence
ALT 2	ALT CTRL 2
ALT 4	ALT CTRL 4
ALT 5	ALT CTRL 5
ALT 7	ALT CTRL 7
ALT 8	ALT CTRL 8
ALT 9	ALT CTRL 9
ALT –	ALT CTRL –
ALT H	None
ALT I	None
ALT J	None
ALT L	None
ALT M	None
ALT ;	None

Protected Keyboard Functions: None CTRL ALT CTRL and ALT

This mode is simply a combination of the CTRL and the ALT protection modes. Refer to the above sections for an explanation of the functionality changes.

4.7 DIAGNOSTICS (DIAG)

The Diag entry on the configuration menu accesses the diagnostics menus, which are used to select and apply tests of terminal functionality at the keyboard. Refer to Section 7, “Diagnostics,” for uses of this menu selection.

The terminal is now configured to communicate with other units in the system. The Model 931 VDT powers up in the online mode.

Programming

5.1 INTRODUCTION

This section describes the programming commands issued by the host computer to control the Model 931 VDT.

All codes in this section are in a two line, stacked format. ASCII characters representing the command are on the top line. The corresponding hex notations are directly underneath.

Commands may be either single character ASCII control codes (i.e. Line Feed, Hex 0A) or multiple character escape commands. Each escape command contains an ASCII escape control character (Hex 1B), the command itself (an ASCII character in the range Hex 20 to Hex 7E), and a specified number and type of arguments. For example, the code for *erase to address* is:

```
ESC  >  Row  Col
  1B  3E  Var  Var
```

Where *Row* and *Col* (column) define the “end of erase” address to be added with each use of the command.

The code for *repeat character n times* is:

```
ESC  k  Char  Count
  1B  6B  Var  Var
```

Where *Char* is the character to be repeated, *Count* is the number of times that character is to be repeated, and *Var* is the hex code representing the character or count in the command argument. Finally, commands requiring variable length arguments (usually text strings) are supported by using the control start (“ESC (”) and control end (“ESC)”) sequences. For example, the command for *write data to message area* is:

```
ESC  G  A  ESC  (... data and attributes ... ESC  )
  1B  47  41  1B  28      data and attributes      1B  29
```

where data and attributes are entered inside the parentheses of the command.

To facilitate screen oriented applications, each character position in the display has been assigned a Row and Column matrix address. Row values may range from 1 to 24 (ASCII codes hex 20 to hex 37), column values may range from 1 to 80 (ASCII codes hex 20 to hex 6F). Table B-4 lists values for row column/addressing.

Some commands require the Model 931 VDT to compute previous or successive row/column addresses (Cursor Right, Back Space, Cursor Down, etc.), when at the rightmost column (80) of Row N, the logical successor is column 1, Row N + 1. Likewise the logical predecessor of column 1, Row N is column 80, Row N-1. When at the lower boundary of the display, the successive row address will be computed one of two ways. If wrap mode is enabled, Row 1 is the successor to Row 24 (the cursor wraps). If wrap mode is disabled, a scroll up function is performed, and the current Row address remains 24.

Likewise, when at the upper boundary of the display, wrap mode enabled causes Row 24 to be the predecessor of Row 1. Wrap mode disabled causes a scroll down function to be performed, and the row address remains 1. (See Define Operational Parameters for Enabling and Disabling wrap mode.)

For convenient reference, commands are presented in thirteen categories:

- Terminal control
- Cursor control
- Erase
- Screen editing
- Attribute
- Character set selection
- Video/keyboard
- Aux device control
- Status line control
- Terminal reporting
- Configuration
- Diagnostic
- Miscellaneous

For quick reference refer to Table 5-1, which lists for each command the transmitted ASCII character string (and beneath the ASCII notation, the hexadecimal (hex) representation). The paragraphs following Table 5-1 describe the format and function of each host command and provide examples.

Table 5-1. Host Computer Commands

Commands	ASCII Characters Hex Code
Terminal Control	
Device Control 3	DC3 13
Device Control 1	DC1 11
Bell	BEL 07
Back Space	BS 08
Carriage Return	CR 0D
Line Feed	LF 0A
Cursor Control	
Cursor Off	ESC R 1B 52
Cursor On	ESC M 1B 4D
Enable/Disable Cursor Blink	ESC V 0 or 1 1B 56 30 or 31
Cursor Down	ESC B 1B 42
Cursor Home	ESC H 1B 48
Cursor Left	ESC D 1B 44
Cursor Right	ESC C 1B 43
Cursor Up	ESC A 1B 41
Set Cursor Address	ESC Y Row Col 1B 59 Var Var

Table 5-1. Host Computer Commands (Continued)

Commands	ASCII Characters Hex Code
Erase	
Erase All	ESC L 1B 4C
Erase to End of Line	ESC I 1B 49
Erase to End of Screen	ESC J 1B 4A
Erase to Address	ESC > Row Column 1B 3E Var Var
Attribute Commands	
Attribute AND	ESC } Att AND... Modifying Code 1B 7D Var
Attribute OR	ESC { Att OR... Modifying Code 1B 7B Var
Set Display Attribute	ESC 4 Att 1B 34 Var
Repeat Attribute to Address	ESC % Att Row Col 1B 25 Var Var Var
Repeat Attribute N Times	ESC j Att Count 1B 6A Var Var
Character Set Selection	
Select and Enter Alternate Character Set	ESC y 1 or 2 1B 79 31 or 32
Select Alternate Character Set	S0 (Shift Out) 0E
Select Primary Character Set	SI (Shift In) 0F
Video Control	
Video Off	ESC ~ 1B 7E
Video On	ESC 1B 7C

Table 5-1. Host Computer Commands (Continued)

Commands	ASCII Characters Hex Code				
Keyboard					
Keyboard Lock	ESC : 1B 3A				
Keyboard Unlock	ESC ; 1B 3B				
Screen Editing					
Scroll Down	ESC b 1B 62				
Scroll Up	ESC a 1B 61				
Move Box	ESC x 1B 78	NRows Var	NCols Var	Row Var	Col Var
Select Line Editing Extent Boundary	ESC # 1B 23	Row Var			
Insert Line	ESC N 1B 4E				
Delete Line	ESC O 1B 4F				
Enable/Disable Character Editing Extent Boundary	ESC \$ 1B 24	0 or 1 30 or 31			
Select Character Editing Extent Boundary	ESC " 1B 22	Row Var	Col Var		
Select Fill Character and Attribute	ESC ! 1B 21	Char Var	Attribute Var		
Insert Character	ESC P 1B 50				
Delete Character	ESC Q 1B 51				
Repeat to Address	ESC ? 1B 3F	Char Var	Row Var	Col Var	
Repeat Character N Times	ESC k 1B 6B	Char Var	Count Var		

Table 5-1. Host Computer Commands (Continued)

Commands	ASCII Characters Hex Code	
Aux Device Control		
Write Data to Device (Transparent Print)	ESC 1B	F 46 ESC 1B (...data... ESC) 28 Var...Var 1B 29
Write Data to Device and Printer Acknowledge	ESC 1B	F 46 SOH 01 1 ESC 1B (...data... ESC) 28 Var...Var 1B 29
Cancel Output	ESC 1B	S 53
Status Line Control		
Write to and Select Alternate Status Line	ESC 1B	G 47 K 4B ESC 1B (...data, attributes ... ESC) 28 Var...Var 1B 29
Restore Primary Status Line	ESC 1B	G 47 L 4C ESC 1B (ESC) 28 1B 29
Write to Message Area	ESC 1B	G 47 A 41 ESC 1B (...data, attributes ... ESC) 28 Var...Var 1B 29
Erase Message	ESC 1B	< 3C
Terminal Reporting		
Read to Address	Host:	ESC @ row col 1B 40 Var Var
	Response:	SOH ESC (...data... ESC) 01 1B 28 Var...Var 1B 29
Read Cursor Position	Host:	ESC 5 1B 35
	Response:	SOH ESC (ESC Y row col ESC) 01 1B 28 1B 59 Var Var 1B 29
Read Status	Host:	ESC 6 1B 36
	Response:	SOH ESC (... 13 status bytes ... ESC) 01 1B 28 Var ... Var 1B 29
Enquiry	Host:	ENQ 05
	Response:	Transmit contents of ABM

Table 5-1. Host Computer Commands (Continued)

Commands	ASCII Characters		Hex Code								
Report Terminal ID	Host:	ESC 1B	G 47	I 49	ESC 1B	(28	7 37	ESC 1B) 29		
	Response:	ESC 1B	G 47	I 49	ESC 1B	(28	9 39	3 33	1 31	ESC 1B) 29
Configuration											
Define Communication Parameters		ESC 1B	G 47	M 4D	ESC 1B	(28	... 4 Bytes ...	ESC 1B) 29		
Define Aux Parameters		ESC 1B	G 47	N 4E	ESC 1B	(28	... 3 Bytes ...	ESC 1B) 29		
Define Operational Parameters		ESC 1B	G 47	B 42	ESC 1B	(28	... 4 Bytes ...	ESC 1B) 29		
Define ABM		ESC 1B	G 47	J 4A	ESC 1B	(28	Count Var	... Data ... Var... Var	ESC 1B) 29	
Enable/Disable Personality Module Mode		ESC 1B	w 77	0 30	or	1 31					
Reset Nonvolatile Memory		ESC 1B	G 47	I 49	ESC 1B	(28	0 30	ESC 1B) 29		
Diagnostic											
Execute RAM Test		ESC 1B	G 47	I 49	ESC 1B	(28	1 31	ESC 1B) 29		
Verify All ROMs		ESC 1B	G 47	I 49	ESC 1B	(28	2 32	ESC 1B) 29		
Barberpole All Character Sets		ESC 1B	G 47	I 49	ESC 1B	(28	3 33	ESC 1B) 29		
Display Screen Adjust Pattern		ESC 1B	G 47	I 49	ESC 1B	(28	4 34	ESC 1B) 29		
Enter Keyboard Test Mode		ESC 1B	G 47	I 49	ESC 1B	(28	5 35	ESC 1B) 29		
Exit Keyboard Test Mode		ESC 1B	G 47	I 49	ESC 1B	(28	6 36	ESC 1B) 29		
External Loopback Test		ESC 1B	G 47	E 45	ESC 1B	(28	... data to be echoed ... Var... Var	ESC 1B) 29		

Table 5-1. Host Computer Commands (Continued)

Commands	ASCII Characters Hex Code
Miscellaneous	
Control Start	ESC (1B 28
Control End	ESC) 1B 29

5.2 TERMINAL CONTROL COMMANDS

These host commands set the operating state of the terminal.

5.2.1 Device Control 3

DC3
13

Device control 3 temporarily suspends data transmission to the host. The BUSY message is displayed in the Comm status message area. This mode is in effect until a DC1 is received or until you press the BREAK key. DC3 works only if the Receive DC1/DC3 configuration option is YES.

5.2.2 Device Control 1

DC1
11

Device control 1 resumes transmission suspended by DC3. RDY is displayed in the Comm status message area. DC1 works only if the Receive DC1/DC3 configuration is YES.

5.2.3 Bell

BEL
07

Bel sounds the alarm bell for 50 to 100 ms. The operator selects the loudness using the keyboard. If the operator selects no sound, the command is effectively disabled because the alarm cannot be heard.

5.2.4 Back Space

BS
08

Back space decrements the column address of the cursor by one if the column value is greater than one. If the cursor is in column 1, it is moved to column 80 of the previous row. Refer to wrap mode information, under "Operational Parameters" (paragraph 5.13.3).

5.2.5 Carriage Return

CR
0D

Carriage return positions the cursor to column 1 of the current line. Additionally, a new line function may be performed if the CR = CR/LF is enabled. If it is disabled, the carriage does not advance to a new line.

5.2.6 Line Feed

LF
0A

Line feed increments the current cursor row address by one. If the cursor is on the last line of the display (row 24), a scroll up function is performed. Refer to wrap mode information under "Operational Parameters" (paragraph 5.13.3).

5.3 CURSOR CONTROL COMMANDS

All characters entered to the screen from the keyboard of the 931 VDT first appear at the current cursor position. Cursor control commands determine the appearance of the cursor (OFF, ON, Blinking) and its motion across the screen by single-character increments (Up, Down, Left, Right) or by larger increments (Cursor Home, Set Cursor Address).

5.3.1 Cursor Off

ESC R
1B 52

Cursor off blanks the cursor from view. The cursor remains blank until a cursor on command is received.

5.3.2 Cursor On

ESC M
1B 4D

Cursor on restores the cursor to view. The default condition is cursor on.

5.3.3 Enable/Disable Cursor Blink

ESC	V	0 or 1
1B	56	30 or 31

Where: 0 = Blinking Disabled
1 = Blinking Enabled

Enable/disable cursor blink selects between a nonblinking (stable) and a blinking cursor.

5.3.4 Cursor Down

ESC	B
1B	42

The cursor down command increments the row address of the current cursor position. If the cursor is at row 24 of the display, currently selected wrap mode rules apply.

5.3.5 Cursor Home

ESC	H
1B	48

Cursor home sets the current cursor address to row 1, column 1.

5.3.6 Cursor Left

ESC	D
1B	44

The cursor left command decrements the column address of the cursor position by one if the column value is greater than 1. If the cursor is in column 1, it moves to column 80 of the previous row.

5.3.7 Cursor Right

ESC	C
1B	43

The cursor right command increments the column address of the cursor by one if the address is less than 80. If the cursor is in column 80, it is repositioned at column 1 of the next row. Currently selected wrap mode rules apply.

5.3.8 Cursor Up

ESC	A
1B	41

The cursor up command decrements the row address of the current cursor position. If the cursor is at row 1, currently selected wrap mode rules apply.

5.3.9 Set Cursor Address

```
ESC  Y  Row  Col
 1B  59  Var  Var
```

The set cursor address command positions the cursor at the indicated address.

5.4 ERASE COMMANDS

Erase commands provide the programmer with three fixed limit choices.

- Erase all
- Erase to the end of the screen
- Erase to the end of the line

In addition, there is one variable limit erase command: the Erase to Address command.

5.4.1 Erase to End of Line

```
ESC  I
 1B  49
```

The erase to end of line command erases all characters from the current cursor position to the end of the current line.

5.4.2 Erase to End of Screen

```
ESC  J
 1B  4A
```

The erase to end of screen command erases all characters from the current cursor position to the end of screen memory.

5.4.3 Erase All

```
ESC  L
 1B  4C
```

The erase all command erases all display memory, resets the attribute latch, resets the character set to primary, and moves the cursor to the home position. The status line is not affected.

5.4.4 Erase to Address

```
ESC  >  Row  Column  
1B  3E  Var  Var
```

The erase to address command erases all characters from the current cursor position to a specified address. Cursor position remains unchanged. The erase feature is active from the cursor position to a location defined by row and column.

5.5 SCREEN EDITING COMMANDS

Edit commands permit the host computer to manipulate (locate, erase, duplicate, insert) data in the terminal display. Editing affects data between the cursor position and a text editing boundary. The host computer can do the following:

1. Edit within a selected area of text without disturbing text beyond the chosen boundary.
2. Select a text editing boundary that is either before or after the cursor.

Editorial changes at the cursor position are usually accommodated by moving text to the right of the cursor. However, in some cases (as when right justifying numbers) a text editing boundary before (to the left of) the cursor is desirable.

The text stream on the screen can be edited in four ways:

- Scrolling
- Shifting a block of text as a unit defined by coordinates
- Moving displayed text line by line
- Changing a continuous character stream, character by character

5.5.1 Scroll Down

```
ESC  b  
1B  62
```

The scroll down command moves the entire contents of the display down one line. The last line disappears. A blank line moves into the top line position.

5.5.2 Scroll Up

```
ESC  a  
1B  61
```

The scroll up command moves the entire contents of the visible display up one line. The first line disappears. A blank line moves into the bottom line position.

5.5.3 Move Box

ESC	x	NRows	NColumns	Row	Column
1B	78	Var	Var	Var	Var

The move box command moves an entire block of displayed data. The command defines a block of data of size N rows, N columns beginning at the current cursor position. Cursor position defines the top left corner of the box. The block moves so that the new top left corner of the box is at the position defined by the entries for row and column.

The moved box can overlay any portion of the original display without loss of data. If the destination of the box extends beyond either column 80 or line 24, the data within the moved box that falls beyond these boundaries is discarded.

Entries for NRows and NColumns are computed as the number of rows and columns of the box (one based), plus hex 20. Note that this differs from zero-based row/column addressing. (See Table B-5.)

5.5.4 Line Insert/Delete Commands

Line insert or delete commands require the programmer to select a line editing boundary if an editing area is to be isolated on the screen. However, because defaults are provided for insert/delete commands, insertions and deletions can be made without specifically selecting editing boundaries. If no boundary has been defined, the command defaults to row 24 on the VDU.

5.5.4.1 Line Editing Extent Boundary.

ESC	#	Row
1B	23	Var

The line editing extent boundary command defines an editing zone between the cursor position and the position defined by Row. Text outside the boundary does not move to adjust for a delete or insert command. If a boundary is not defined, the command defaults to row 24. That is, lines between the cursor position and the bottom of the screen shift to accommodate changes in the length of the data stream.

5.5.4.2 Insert Line.

ESC	N
1B	4E

The insert line command inserts a blank line at the cursor position. Displaced lines shift toward the current line editing boundary. This boundary is defined by the last select line editing extent boundary command.

5.5.4.3 Delete Line.

ESC	O
1B	4F

The delete line command deletes the line on which the cursor is currently located. All lines from the deleted line to the current line editing boundary move toward the deleted line to fill the vacated space, and a blank line is inserted at the line editing boundary. The line editing boundary is defined by the last line editing extent boundary command.

5.5.5 Character Insert/Delete Commands

Using these commands, a programmer can insert or delete displayed characters one at a time. The command sequence for inserting or deleting a character follows:

1. Enable the character editing extent mode.
2. Select the character editing extent boundary.
3. Select fill character and attribute.
4. Insert and delete characters.

Because defaults are provided for insert/delete commands, insertions and deletions can be made without specifically enabling the character editing extent mode, selecting editing boundaries, or choosing fill characters.

5.5.5.1 Enable/Disable Character Editing Extent Mode.

ESC	\$	Char
1B	24	Var

Where:

Char =	0	Disabled
	30	
Char =	1	Enabled
	31	

When the character editing extent mode is disabled, the current character editing extent boundary is column 80 of the line containing the cursor. When this mode is enabled, the character editing extent boundary is defined by the last character editing extent command (see next command). Insert character and delete character commands cause characters to shift within but not beyond this boundary. Text beyond the selected boundary is not affected. The command defaults to **disable**.

5.5.5.2 Select Character Editing Extent Boundary.

ESC	"	Row	Col
1B	22	Var	Var

This command defines a position in display memory used as an editing boundary for text adjustments caused by insert character and delete character commands. It is used only if the character editing extent mode is enabled. Only text between the cursor position and the editing boundary is subject to insert and delete commands. The default boundary is row 24, column 80.

If the character editing extent mode is disabled, the default boundary is row 24, column 80.

5.5.5.3 Select Fill Character and Attribute.

ESC	!	Char	Attribute
1B	21	Var	Var

This command defines the character and attribute used as a fill character for the insert character and delete character commands. The specified fill character must be a displayable character and the specified attribute value must be a valid argument for the set display attribute command.

The default for this command is a blank (hex 20) character with all attributes off.

5.5.5.4 Insert Character.

ESC	P
1B	50

This command inserts one character at the current cursor position. The inserted character is defined by the last select character and attribute command. Displaced characters shift from the cursor position toward but not beyond the current editing boundary.

5.5.5.5 Delete Character.

ESC	Q
1B	51

This command deletes one character at the current cursor position. Characters from the cursor position to the character editing boundary shift toward the cursor to fill the vacated space, leaving a vacant space at the character boundary. This space is filled by the character and attribute defined by the last select fill character and attribute command.

5.5.6 Repeat Commands

The following commands cause characters to be repeated.

5.5.6.1 Repeat to Address.

ESC	?	Char	Row	Col
1B	3F	Var	Var	Var

The repeat to address command repeats the indicated character from the current cursor position to the indicated address.

5.5.6.2 Repeat Character N Times.

ESC	k	Char	Count
1B	6B	Var	Var

This command repeats a selected character N times, starting at the current cursor position. The cursor is placed at the character position immediately after the last character. The character repeat count is computed as the hexadecimal value of the desired count, plus hex 1F. For example, a repeat count of 1 is hex 20. The largest valid count argument is hex 6F. The maximum value of the character count is hex 50 (80 decimal).

5.6 ATTRIBUTE COMMANDS

The following five attribute features determine the character display:

- High intensity
- Reverse image character
- Underline character
- Non-display (character blank)
- Blinking character

All attributes can be used at the same time or in any desired combination. However, when non-display (blank) is enabled, settings for other attributes cannot be viewed.

Attribute selections are made by changing bit settings loaded onto an 8-bit data word having bit seven always set to On. Refer to Figure 5-1 for attribute bit pattern settings.

Table 5-2. ASCII Characters and Hex Codes for Display Attributes

Hex Code	ASCII Character	High Intensity	Reverse Image	Underline	Char Blank	Char Blink
40	@					
41	A	On				
42	B		On			
43	C	On	On			
44	D			On		
45	E	On		On		
46	F		On	On		
47	G	On	On	On		
48	H				On	
49	I	On			On	
4A	J		On		On	
4B	K	On	On		On	
4C	L			On	On	
4D	M	On		On	On	
4E	N		On	On	On	
4F	O	On	On	On	On	
50	P					On
51	Q	On				On
52	R		On			On
53	S	On	On			On
54	T			On		On
55	U	On		On		On
56	V		On	On		On
57	W	On	On	On		On
58	X				On	On
59	Y	On			On	On
5A	Z		On		On	On
5B	[On	On		On	On
5C	\			On	On	On
5D]	On		On	On	On
5E	^		On	On	On	On
5F	_	On	On	On	On	On

Note:

Any attribute combination that includes Char Blank (non-display) will not display.

The code for the desired attribute is read from the table and inserted in the command strings that follow at variable.

Each time a character is written to memory, the current attribute value of the latch is copied with it. Therefore, there are two locations where the attribute values of the data stream can be changed:

- Attribute Latch
- Memory

5.6.1 Attribute Latch

The attribute latch records the attribute value of each character to be written to the screen. These three commands change attribute values at the latch:

- Set display attribute
- Attribute AND
- Attribute OR

5.6.1.1 Set Display Attribute.

```
ESC  4  Attribute
1B  34  Variable
```

The set display attribute command causes characters received after the command to acquire the indicated display attribute. This attribute selection is active until an attribute AND, Attribute OR, or another Set Display Attribute command is received. This command immediately changes the attribute latch value to the value defined by the variable.

5.6.1.2 Attribute AND . . . and Attribute OR . . . To change one or more attributes on the display byte, you can transmit a command that instructs the latch to add a modifying code (sent with the command) to the current code. The sum of the attribute and the modifier becomes the new attribute value. This new value controls display attributes, changing one or more of them, until a new attribute command is received.

There are two methods for combining modifier and latch values:

Attribute AND . . .

A code is chosen that, when ANDed with the attribute latch, switches on the desired display attribute. The value of the modifying code at the display attribute latch defines the display attribute of each character received after the command.

```
ESC  }  Attribute AND . . . Modifying Byte = New Attribute Value
1B  7D  Variable
```

Attribute OR...

A code is chosen that, when ORed with the attribute latch, switches on the desired display attribute. The value of the modifying code at the display attribute latch defines the display appearance of each character received after the command.

```
ESC   {   Attribute OR... Modifying Byte = New Attribute Value
 1B   7B   Variable
```

5.6.2 Memory

Two commands can be used to change an attribute in memory:

- Repeat to address
- Repeat N times

5.6.3 Repeat Attribute to Address

```
ESC   %   Att Row Col
 1B   25  Var Var  Var
```

Where Att = the attribute value
Row and Col = the address terminating the command.

This command permits redefining of display attributes from the current cursor position to the indicated address. The attributes are set to the value indicated in the command. The code for the desired attribute selection is in Table 5-2. Using this command, you can instantly insert an attribute selection into attribute display memory without changing attribute latch settings in effect or retransmitting data.

5.6.4 Repeat Attribute N Times

```
ESC   j   Att Count
 1B   6A  Var  Var
```

This command permits a selection of attributes to be repeated N times from the current cursor position. The code for the desired attribute combination is in Table 5-2. It is inserted as the attribute variable in the command above and is followed by the number of repeats to be performed. Using this command, you can instantly insert an attribute selection into attribute display memory without changing attribute latch settings in effect.

The count is computed as the hexadecimal value of the desired count, plus hex 1F. For example, a repeat count of 1 attribute is hex 20. The largest valid count argument is hex 6F. Thus, the maximum repeat count is hex 50 (80 decimal).

5.7 CHARACTER SET SELECTION COMMANDS

These commands select the character set used to represent the data stream.

5.7.1 Select and Enter Alternate Character Set

```
ESC  y  1  or  2
    1B  79 31  or 32
```

Where: 1 selects SC1, an undefined character set
 2 selects SC2, a set of 32-line drawing characters

This command selects one of several alternate character sets as an alternate font. The chosen character set becomes the current font.

5.7.2 Select Alternate Character Set

```
SO
OE
```

Characters following this command acquire the font of the selected alternate character set.

5.7.3 Select Primary Character Set

```
SI
OF
```

Characters following this command acquire the font of the primary (default) character set.

5.8 KEYBOARD COMMANDS

These commands provide host control over data entry at the terminal keyboard.

5.8.1 Keyboard Lock

```
ESC  :
    1B 3A
```

The keyboard lock command prevents interference with host transmission. Data from the keyboard is discarded and the alarm sounds once for each key code received.

5.8.2 Keyboard Unlock

```
ESC  ;
    1B 3B
```

The keyboard unlock command releases the terminal from the keyboard lock mode, allowing two-way communications to resume.

5.9 VIDEO COMMANDS

These commands govern the screen display of the Model 931 VDT.

5.9.1 Video Off

```
ESC  ~  
1B  7E
```

The video off command blanks the video display from view. Data is retained in display memory.

5.9.2 Video On

```
ESC  |  
1B  7C
```

The video on command restores (unblanks) the display of the VDU. Data removed from the screen by the video off command and retained in display memory returns to the screen.

5.10 AUXILIARY DEVICE CONTROL COMMANDS

The host computer has control over a printer attached to the terminal. Commands that govern the printer follow.

5.10.1 Write Data to Device (Transparent Print)

```
ESC  F  ESC  (... data - 132 characters maximum ... ESC )  
1B  46  1B  28 ... data - 132 characters maximum ... 1B  29
```

The write data to device command routes data enclosed by the control start/control end pair to the auxiliary device without being reformatted by the terminal. All control characters (except ESC) pass to the auxiliary device.

5.10.2 Printer Acknowledge

If an acknowledgement from a printer is desired by the communicating host, a command is embedded in the data stream to the printer. The format of the command follows.

```
ESC  F  SOH 1  ESC  ( ... data - 132 characters maximum ... ESC )  
1B  46  01  31  1B  28 ... data - 132 characters maximum ... 1B  29
```

The printer responds to the acknowledge command after the last character in the stream successfully transmits to the printer from the Model 931 VDT. The format of the printer acknowledge response follows.

```
ESC  1  
1B  31
```

This is a positive ACK response indicating that data passed to the printer. When the response is received, the terminal is ready to accept up to 134 more characters for the printer. This provides a method to pace the flow of data to the printer. For more information on printer status, refer to the read status command.

5.10.3 Cancel Output

```
ESC  S
1B  53
```

The cancel output command causes the terminal to abort current output to the auxiliary device. The aux data aborted flag will be set for the next read status message.

5.11 STATUS LINE CONTROL COMMANDS

The 25th line of the display area is used by the host to display messages for the terminal operator. Display attributes can be used to emphasize the status line by embedding a display attribute command in the write to and select alternate status line or the write to message area command. These attribute commands do not affect any other portion of screen memory. If no attributes are selected, the default is normal intensity with all other attributes off.

5.11.1 Write to Message Area

```
ESC  G  A  ESC  (... data and attributes ... ESC )
1B  47  41  1B  28  Var...Var                1B  29
```

This command is used by the host to write a message to the screen of the terminal. The message is written to the host message area of the primary status line in columns 1 through 40.

5.11.2 Erase Message

```
ESC  <
1B  3C
```

This command erases a message in the host message area (columns 1 to 40 of the primary status line).

5.11.3 Write to and Select Alternate Status Line

```
ESC  G  K  ESC  (... data and attributes ... ESC )
1B  47  4B  1B  28  Var...Var                1B  29
```

This command is used where more space is needed for a message than will fit in columns 1 to 40, or when a blank status line is preferred. Messages are written to the status line in columns 1 through 80. The command suppresses the primary status line.

5.11.4 Restore Primary Status Line

```
ESC  G  L  ESC  (  ESC  )
1B  47  4C  1B  28  1B  29
```

This command cancels the alternate status line and returns the primary status line to the screen.

5.12 TERMINAL REPORTING COMMANDS

The host issues commands to the terminal to obtain reports on function. These commands follow.

5.12.1 Read to Address

```
ESC   @   Row   Column
1B   40  Var   Var
```

The host requests a display memory report from the current cursor position to the address specified by row and column.

The terminal responds in this format:

```
SOH   ESC  (...data... ESC  )
01    1B   28 Var...Var 1B 29
```

If attributes transmitted of the last define operational parameters command is selected, the response will include attribute and character set information. Attributes may change independently or together with changes in character sets. Insertion of character set changes causes ESC Y 2 and SI (shift in) in the data stream to denote alternate and primary character set selection, respectively. Attribute changes are denoted by inserting ESC 4 VAR, where VAR represents the appropriate attribute variable from Table 5-2.

5.12.2 Read Cursor Position

```
ESC   5
1B   35
```

This command causes the terminal to transmit current cursor position to the host. The terminal responds:

```
SOH   ESC  ( ESC Y row col ESC )
01    1B   28 1B 59 Var Var 1B 29
```

where row and column define cursor location.

5.12.3 Read Status

```
ESC   6
1B   36
```

The read status command causes the terminal to transmit its current status statistics to the host.

The terminal responds:

```
SOH   ESC  (... 13 Status Bytes... ESC )
01    1B   28 Var...Var          1B 29
```

Bit settings for all 13 data characters (bytes) of the response appear in Figure 5-2.

CHARACTER	BIT PATTERN	READ STATUS FUNCTION
CHARACTER 1	0 1 0 0 0 0 0 0	NONE
CHARACTER 2	0 1 0 0 0 0 0 0	NONE
CHARACTER 3	0 1 0 0 0 0 0 0	NONE
CHARACTER 4	0 1 0 0 0 0 0 0	NONE
CHARACTER 5	0 1 0 0 0 0 0 0	SET TO ONE-CURSOR ON SET TO ONE-VIDEO ON NONE NONE NONE ALWAYS SET TO ONE PARITY
CHARACTER 6	0 1 0 0 0 0 0 0	NUMBER OF PARITY ERRORS SET TO ONE-COUNT OVERFLOWED ALWAYS SET TO ONE PARITY
CHARACTER 7	0 1 0 0 0 0 0 0	SET TO ONE IF AUX DEVICE READY SET TO ONE IF AUX DATA ABORTED SET TO ONE IF AUX DEVICE ONLINE NONE NONE NONE ALWAYS SET TO ONE PARITY
CHARACTER 8	0 1 0 0 0 0 0 0	NONE
CHARACTER 9	0 1 0 0 0 0 0 0	NONE SET-SPECIAL CHARACTER SET ONE NONE NONE SET-SPECIAL CHARACTER SET TWO NONE ALWAYS SET TO ONE PARITY
CHARACTER 10	0 1 0 0 0 0 0 0	SET TO ONE-KEYBOARD LOCKED NONE NONE NONE NONE NONE ALWAYS SET TO ONE PARITY
CHARACTER 11	0 1 0 0 0 0 0 0	NONE
CHARACTER 12	0 1 0 0 0 0 0 0	NONE
CHARACTER 13	0 1 0 0 0 0 0 0	NONE

2229228-17

Figure 5-2. Status Byte Code Format

The ASCII characters and codes for all reports shown in Figure 5-2 are in Table 5-3. Refer to the figure and table to interpret the data string message.

Table 5-3. ASCII Characters and Codes for Status Responses

Feature		Byte No	Hex	ASCII	
Reserved		1	40	@	
Reserved		2	40	@	
Reserved		3	40	@	
Reserved		4	40	@	
Cursor Off/Video Off		5	40	@	
Cursor On/Video Off		5	41	A	
Cursor Off/Video On		5	42	B	
Cursor On/Video On		5	43	C	
Number of Parity Errors	}	1	6	41	A
		2	6	42	B
		3	6	44	D
		4	6	48	H
		5	6	50	P
Count Overflow On		6	60	,	
Count Overflow Off		6	40	@	
Aux Offline		7	40	@	
Aux Data Aborted		7	42	B	
Aux Rdy		7	44	D	
Aux Busy		7	45	E	
Reserved		8	40	@	
Character Set One On		9	42	B	
Character Set One OFF		9	40	@	
Character Set Two On		9	50	P	
Character Set Two OFF		9	40	@	
Keyboard Locked		10	41	A	
Reserved		11	40	@	
Reserved		12	40	@	
Reserved		13	40	@	

The following message is an example of a status report:

```
SOH  ESC (  @  @  @  @  A  @  A  A  @  @  @  @  ESC  )
01  1B 28 40 40 40 40 41 40 41 41 40 40 40 40 1B 29
```

5.12.4 Enquiry

```
ENQ
05
```

The enquiry command causes the terminal to transmit the contents of the answerback memory.

5.12.5 Report Terminal ID

```
ESC  G  I  ESC  (  7  ESC  )
1B  47  49  1B  28  37  1B  29
```

This command causes the terminal to report a text string representing model number.

The terminal responds:

```
ESC  G  I  ESC  (  9  3  1  ESC  )
1B  47  49  1B  28  39  33  31  1B  29
```

5.13 CONFIGURATION COMMANDS

The host computer can issue configuration commands to the terminal. These commands configure the terminal for the host environment. They perform functions equivalent to those available in the configuration mode, without operator intervention.

5.13.1 Comm Port Parameters

The command sequence for configuring the Comm port follows.

```
ESC  G  M  ESC  (  ... Byte 1,2,3,4...  ESC  )
1B  47  4D  1B  28  Var  Var  Var  Var  1B  29
```

Make choices by setting character bit patterns on four data bytes. The programmer must enter coded choices for all variables (Var) in this command string.

Table 5-4 lists the ASCII characters and hex codes for all Comm configuration settings. Use the table to read a command string or define parameters for insertion into a command string.

Table 5-4. ASCII Characters and Codes for Comm Port Configuration

Byte One				
Baud Rate	Space Parity	Even Parity	Mark Parity	Odd Parity
300	B 42	R 52	b 62	r 72
600	C 43	S 53	c 63	s 73
<u>1200</u>	D 44	T 54	d 64	t 74
2400	E 45	U 55	e 65	u 75
4800	G 47	W 57	g 67	w 77
9600	I 49	Y 59	i 69	y 79
19 200	J 4A	Z 5A	j 6A	z 7A

Byte Two		
	EIA Port Selected	Internal Port Selected
Full Duplex	@ <u>40</u>	' 60
Reverse Channel Enabled On = Rdy	X 58	x 78
Reverse Channel Enabled Off = Rdy	H 48	h 68

Byte Three		
Reserved	@ <u>40</u>	

Byte Four		
	Rev DC1/DC3 Off	Rev DC/DC3 On
Check received character parity	H 48	D 44
No check of parity	@ <u>40</u>	L 4C

Note:
Underlined values are factory defaults.

5.13.2 Aux Port Parameters

The command sequence for configuring the Aux port (printer) follows.

```
ESC  G  N  ESC  (  ... 3 Bytes ...  ESC  )
1B  47  4E  1B  28  Var  Var  Var  1B  29
```

The programmer makes choices by setting character bit patterns on three data bytes. The programmer enters coded choices for all variables (Var) in this command. Table 5-5 lists the ASCII characters and hex codes for all Aux configuration settings. Use the table to read a command string or define parameters for insertion into a command string.

Table 5-5. ASCII Characters and Codes for Aux Port Configuration

Byte One		Even Parity	Odd Parity
Baud Rate			
300		R 52	r 72
600		S 53	s 73
1200		T 54	t 74
2400		U 55	u 75
<u>4800</u>		W <u>57</u>	w 77
9600		Y 59	y 79
Byte Two			
Reverse Channel Disabled		@ 40	
Reverse Channel Enabled On = Rdy		X <u>58</u>	
Reverse Channel Enabled Off = Rdy		H 48	
Byte Three			
Aux Enable		@ 40	
Aux Disable		H <u>48</u>	
Note:			
Underlined values are factory defaults.			

5.13.3 Operational Parameters

```

ESC  G  B  ESC  (  ... Bytes 1,2,3,4 ...  ESC )
1B  47  42  1B  28  Var Var Var Var  1B  29
    
```

The programmer makes choices by setting character bit patterns on three data bytes. The programmer enters coded choices for all variables (Var) in this command string.

Table 5-6 lists the ASCII characters and hex codes for all operational settings. Use the table to read a command string or define parameters for insertion into a command string.

Table 5-6. ASCII Characters and Hex Codes for Operational Parameters

Byte One			
	Cursor Wrap Enabled		B 42
	Cursor Wrap Disabled		@ <u>40</u>
Byte Two			
	Bell On		B 42
	Bell Off		@ 40
Byte Three			
	Carriage Return	Attributes Transmitted	Attributes Not transmitted
	CR = CR/LF	a 61	A 41
	CR = CR	' 60	@ <u>40</u>
Byte Four			
	Reserved	@ <u>40</u>	
Note:			
Underlined values are factory defaults.			

5.13.4 Answerback Memory (ABM)

```
ESC  G  J  ESC  (  Count...Data...  ESC  )
1B  47  4A  1B  28  Var  Var...Var  1B  29
```

This is a terminal response to the ENQ command that defines the contents of the ABM. It identifies whether or not the terminal is on the network, ensures data integrity, and makes sure storage space is maintained in the ABM. The count is added to hex 20 (O based). Maximum transmission is 32 characters.

5.13.5 Enable/Disable Personality Module Mode

```
ESC  w    0 or 1
1B  77  30 or 31
```

Where: 0 = PM Disabled
1 = PM Enabled

In some applications, it may be desirable to prevent the operator from going offline or from entering the configuration mode. The terminal processes key codes for ALT 4 (on/offline) and ALT/SHIFT/BACKSPACE (configuration mode) as attention interrupt keys when PM is enabled. When PM is disabled, the terminal processes ALT 4 and ALT/SHIFT/BACKSPACE locally as operator commands. The default mode of this command is PM Disabled.

5.13.6 Reset Nonvolatile Memory

CAUTION

The reset nonvolatile memory command can disrupt communication by removing preset host/terminal configurations (communication parameters and terminal ID). Therefore, be cautious when you use it.

```
ESC  G  I  ESC  (  0  ESC  )
1B  47  49  1B  28  30  1B  29
```

This command resets nonvolatile memory to the factory default values.

5.14 DIAGNOSTIC COMMANDS

These commands, which are functionally equivalent to the configuration mode diagnostic tests, allow a host computer to perform diagnostic tests remotely, without operator intervention.

5.14.1 Execute RAM Test

```
ESC  G  I  ESC  ( 1  ESC  )
1B  47 49 1B  28 31 1B  29
```

This command implements the RAM test. The results of the tests are reported to the host. The terminal responds:

```
ESC  G  I  ESC  ( Status ESC  )
1B  47 49 1B  28 Var 1B  29
```

Where: Status = 50H (P) if test passed
 Status = 46H (F) if test failed

5.14.2 Verify All ROMs

```
ESC  G  I  ESC  ( 2  ESC  )
1B  47 49 1B  28 32 1B  29
```

This command tests all ROMs. A cycle redundancy check (CRC) is done for each ROM, and the results are compared with CRC values stored in each ROM.

The response contains up to four text fields for each ROM installed (up to a maximum of four ROMs). These fields are version, revision, part number (ROM ID features), and status of the test. The terminal responds:

```
ESC  G  I  ESC  ( V,R,N,S..., V,R,N,S... ESC  )
1B  47 49 1B  28  Var... Var          1B  29
```

Where:

- V = 1 Numeric digit for the version
- R = 1 Alpha character for the revision level
- N = 11 numeric digits for the TI Part No.
- S = P (50H) if test passed
- S = F (46H) if test failed
- , = Field delimiter

5.14.3 B-Pole All Character Sets

```
ESC  G  I  ESC  ( 3  ESC  )
1B  47 49 1B  28 33 1B  29
```

This test displays a b-pole pattern for all characters and attributes in the terminal. Results do not return to the host.

5.14.4 VDU Adjust Pattern

```
ESC  G  I  ESC  (  4  ESC  )
1B  47  49  1B  28  34  1B  29
```

This test fills the 25 rows of the screen with the character O at normal intensity with no attributes enabled. Results do not return to the host.

5.14.5 Enter Keyboard Test Mode

```
ESC  G  I  ESC  (  5  ESC  )
1B  47  49  1B  28  35  1B  29
```

Following this command, key codes are reported to the host in ASCII/hex representation (see Appendix C). The test is active until an exit keyboard test mode is received. The host may invoke other commands while this mode is active. No response returns to the host.

5.14.6 Exit Keyboard Test Mode

```
ESC  G  I  ESC  (  6  ESC  )
1B  47  49  1B  28  36  1B  29
```

This command terminates the keyboard test.

5.14.7 External Loopback Test

```
ESC  G      E  ESC  (  ...Var...  ESC  )
1B  47      45  1B  28  Var...Var  1B  29
```

This test causes the terminal to echo a character string back to the host, where Var is the data to be echoed.

5.15 MISCELLANEOUS COMMANDS

The following commands delimit text strings in a command sequence.

5.15.1 Control Start

```
ESC  (
1B  28
```

This command delimits the start of a text string to be used as a command argument. All text string commands begin with this command.

5.15.2 Control End

ESC)
1B 29

This command delimits the end of a text string. It is used as a terminator for the Control Start command. All text string commands end with this command.

Operation

6.1 INTRODUCTION

This section provides operating information for the Model 931 VDT. It includes the following:

- Video display unit description
- Keyboard description
- Terminal adjustments
- Establishing communications
- Care and cleaning

6.2 VIDEO DISPLAY UNIT DESCRIPTION

The Model 931 VDT is an operating part of a computer system configured to the requirements of a specific installation. Many of its functions are controlled by the host, allowing each VDT to be tailored to the system. The following paragraphs describe the operations common to all applications.

When the Model 931 VDT power is on (switch set to 1), the 25-line, 80-column screen is divided into two active areas. The active display areas are:

- The main display area of 24 lines and 80 columns
- The Status Line on line 25

Figure 6-1 shows the functional areas of the screen.

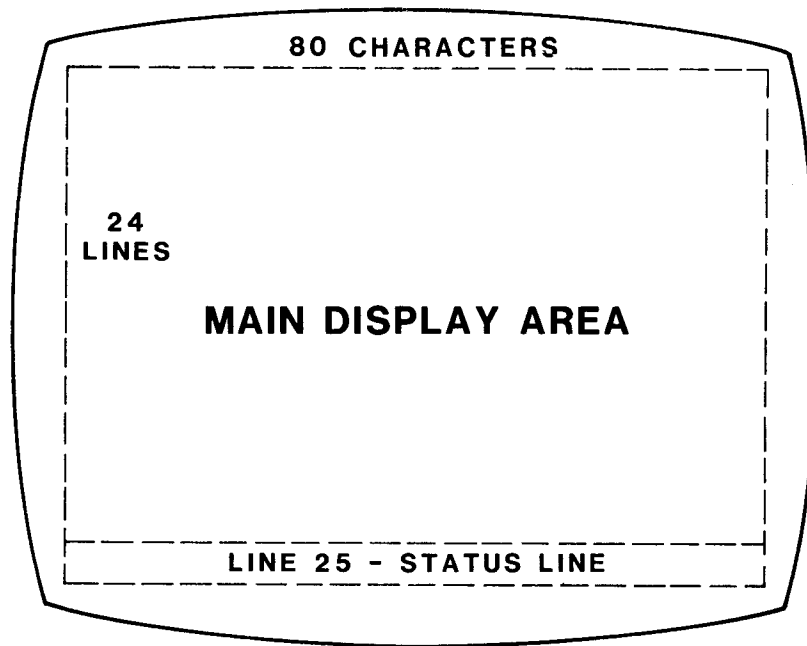

2229228-18

Figure 6-1. Model 931 VDT Screen Areas

6.2.1 Main Display Area

All data input from the keyboard or the host appears within the main display area.

6.2.2 Status Line

The 25th line of the screen is the status line. It is reserved for monitoring communications among the host, the Model 931 VDT, and a printer (if attached), and for performing diagnostic tests. The unique features of the status line include the following:

- It cannot be addressed by the cursor.
- The operator cannot enter data on the status line.
- It cannot be scrolled.
- Display attributes selected on the status line do not affect display attributes elsewhere on the screen.

Figure 6-2 shows the display fields on the status line.

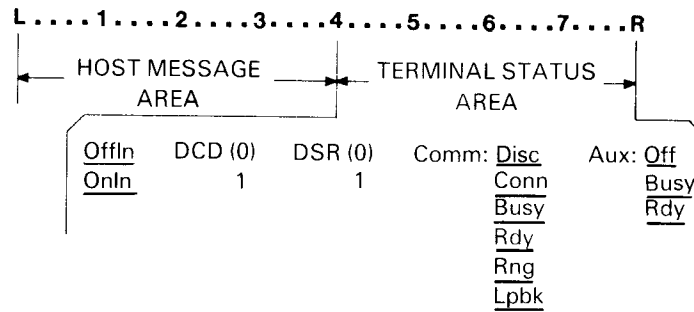

2229228-19

Figure 6-2. Primary Status Line Format

The status line provides two kinds of displays:

- The Host Message area, which shows messages from the host computer
- The Terminal Status area, which shows messages from the terminal concerning its communication status with the host and printer

6.2.2.1 Host Message Area. The host computer controls a 40-column field (Columns 1-40) of the Primary Status Line. Figure 6-2. The message remains visible until the host issues another command (a new message or erase message signal).

6.2.2.2 Terminal Status Area. The terminal controls the right 40 columns of the status line referred to as the terminal status area. Information concerning communication and auxiliary port status as well as error messages is reported here. Five communications parameters are reported. They are:

- Offline/Online (Offln/Onln)
- Data Carrier Detect (DCD)
- Data Set Ready (DSR)
- Comm port (Comm)
- Aux port (Aux) end list

Table 6-1 explains these messages.

Table 6-1. Terminal Status Line Messages

Column	Message	Meaning
42 – 46	<u>Offln</u>	The terminal is in the offline mode (DTR = 0). Data cannot be transmitted or received.
	<u>Onln</u>	The terminal is in the online mode (DTR = 1). Data can be transmitted and received.
48 – 53	DCD(0)	Comm port data carrier detect signal is off. A valid data carrier signal is not received or DTR and/or DSR is off.
	DCD(1)	Comm port data carrier detect signal is on. A valid data carrier signal is being received and both DRT and DSR are on.
55 – 60	DSR(0)	Comm port data set ready signal is off. Data channel is not established
	DSR(1)	Comm port data set ready signal is on. Data channel established.
62 – 70	Comm: <u>Conn</u>	Comm port is in "Connect" state. Comm link made with host, but carrier is not established.
	Comm: <u>Disc</u>	Comm port is in "Disconnect" state. Comm link not established with host.
	Comm: <u>Rdy</u>	Comm port is in "Ready" state. Comm link made and carrier established. Data can be transmitted.
	Comm: <u>Busy</u>	Comm port is in "Busy" state. Host is Busy. Data held until Rdy is received.
	Comm: <u>Rng</u>	Comm port ring indicate signal is on. Modem data phone (if used) is ringing. Terminal must be online to answer.
	Comm: <u>Lpbk</u>	The terminal has been placed in the diagnostics loopback mode of operation. See Section 7, "Diagnostics" for further information.
72 – 80	Aux: <u>Off</u>	Auxiliary device is in "Off" state. Aux device is offline, not connected, or not configured.
	Aux: <u>Rdy</u>	Auxiliary device is in "Ready" state. Data can be transmitted to Aux device.
	Aux: <u>Busy</u>	Auxiliary device is in "Busy" state. Aux device is busy. Data transmission is stopped.

When the terminal powers up, the system completes a set of protocol exchanges to establish an active communication channel between the Model 931 VDT and the host. These exchanges are reflected in the messages displayed in columns 48-53 and 55-60 of the terminal status area. The following message sequence is displayed in the terminal status area when communication begins:

1. The terminal powers up and goes online. The first entry in the terminal status area reads online.
2. DCD (Data Carrier Detect, columns 48 to 53) changes from 0 to 1 to indicate that a channel for communications has been established between the local and remote sites. In modem environments, DCD is normally turned on shortly after the phone is placed in the data mode.
3. DSR (Data Set Ready, columns 55 to 60) changes from 0 to 1 to indicate that the modem has established a connection through interface circuit. In modem environments, DSR is normally turned on after an outgoing call is successfully dialed.
4. The remaining two message areas, Comm and Aux, advise the operator of the overall status of each of the two interface ports. For the meanings of specific messages displayed in the Comm and Aux areas of the status line report, refer to Table 6-1.

NOTE

When Comm: Rdy is displayed, DCD and DSR must both be 1. The DCD (1) status reflects reception of a valid carrier signal. DTR and DSR must both be on for a carrier (DCD) to be considered valid.

6.2.3 Alternate Status Line

In some instances, the host sends a message longer than the space available in the host message area. In such cases, the entire 80 columns of the status line are available when a "Write to and select alternate status line" command is used. This command suppresses the host message and terminal status areas of the primary status line so that a message of up to 80 characters can be displayed. This host message is displayed until another host command (select alternate status line, or restore primary status line) is received.

When the terminal is powered up it defaults to the primary status line.

The host determines the message sent to the terminal and selects the line (primary or alternate) on which it is displayed. If the host sends no message to the alternate status line, the line remains blank. Commands for controlling the status line are in Section 5, "Programming."

The terminal operator may toggle between primary and alternate status lines. To select the alternate status line do this:

1. Press and hold the **ALT** key (or the **ALT** and **CTRL** keys if **ALT** keys are protected), then press the **2** key.
2. Repeat this procedure to reinstate the primary status line.

The operator may also choose whether or not the status line is to be displayed or blanked (nondisplay). To select nondisplay of the primary or alternate status lines do this:

1. Press and hold the **ALT** and **SHIFT** keys, then press the **2** key.
2. Repeat the procedure to display the status line.

6.3 KEYBOARD DESCRIPTION

The keyboard, which is shown in Figure 6-3, is a separate unit. It is designed for the convenience of the operator. A six-foot, coiled cord permits the operator to place the keyboard in the most convenient, comfortable position possible. The 103 keys are arranged in stepped rows set in an adjustable tilt, low-profile base.

Figure 6-3 shows the standard United States keyboard. Appendix A includes drawings of all international keyboards.

Figure 6-3 shows the five groups of keys of the Model 931 VDT keyboard:

- The alphanumeric group enters letters, numbers, punctuation, and special symbols similar to an ordinary typewriter. The keycaps of the F and J keys are indented to help the operator find the home key when his or her hands extend left and right beyond the alphanumeric key cluster.
- The cursor control group positions the cursor for data entry.
- The numeric group enters numbers using a calculator-style keypad.
- The editing group allows the operator to enter and change text by character or block.
- The special function keys perform command functions that vary with application.

The function of each key depends on the host applications program established for the installation. Each key sends a unique code to the host computer. Appendix C contains a complete list of defined codes. The code for each key can be altered by pressing a mode key (**SHIFT**, **CAPS LOCK**, **CTRL**, **ALT**, or combination of these) simultaneously with the desired key. Table 6-2 lists the primary uses of these mode keys. Pressing keys that are not defined in Appendix C causes the terminal to sound an alarm.

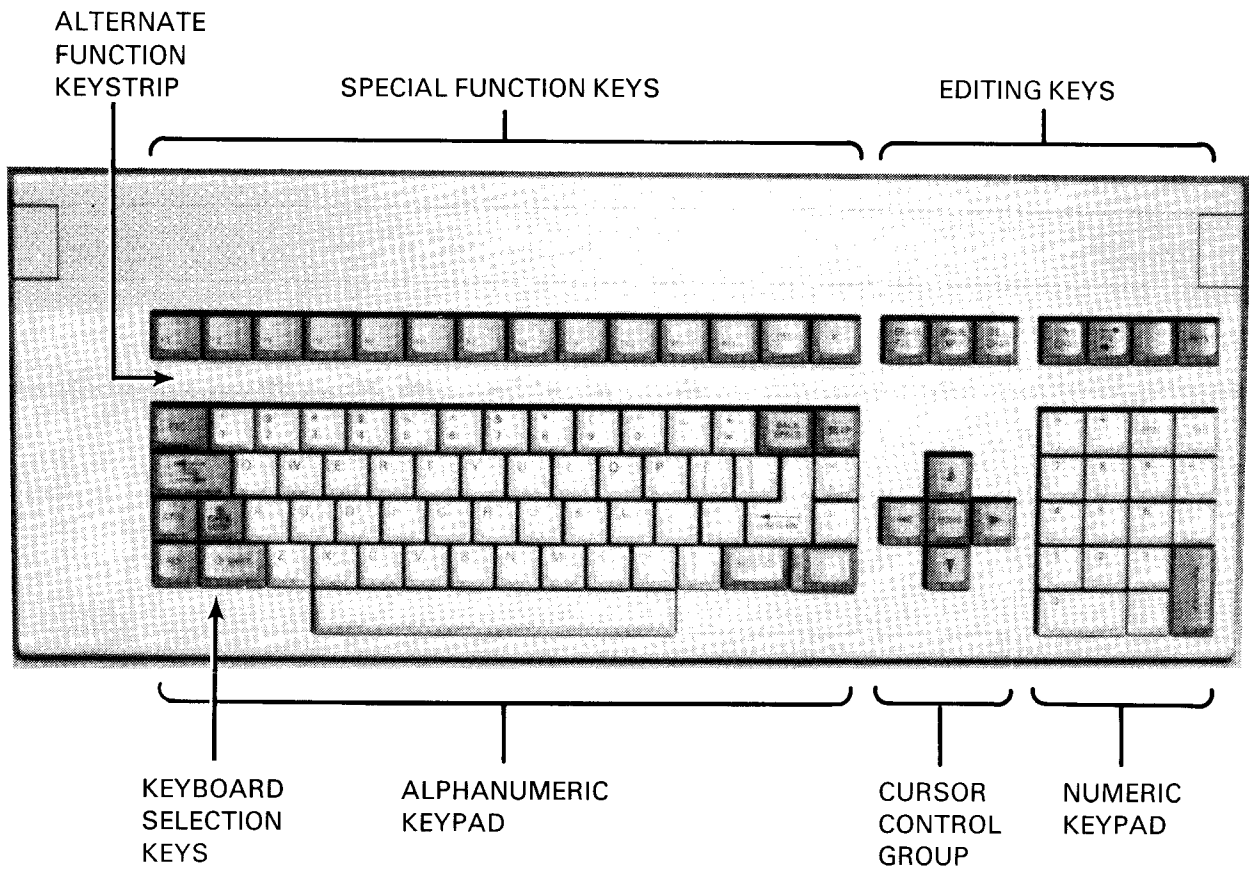

2229228-20

Figure 6-3. US Standard Keyboard

Table 6-2. Keyboard Mode Key Selections and Functions

Mode Keys	Function	Description
Normal (No SHIFT, CTRL, ALT, etc.)	Data entry and editing	Numerals and all lowercase characters. Includes cursor control, editing and special function keys.
SHIFT	Data entry and editing	Symbols and all uppercase characters. Includes cursor control, editing and special function keys.
CAPS LOCK	Data entry and editing	Numerals and all uppercase characters. Includes cursor control, editing and special function keys.
ALT	Terminal convenience adjustments	Reverse image, highlight, bell volume, brightness, cursor control. (Operative when keyboard protection is off.)
CTRL, ALT (pressed simultaneously)	Terminal convenience adjustments	Reverse image, highlight, bell volume, brightness. (Replaces ALT mode when ALT keys are protected).
SHIFT, ALT (pressed simultaneously)	Terminal control functions	Blank status line, cancel printer output, unlock keyboard, enter/exit programmer configuration.
CTRL	Command functions	ANSI Control Codes (Hex 0 to 1F)
SHIFT, CTRL (pressed simultaneously)	Command functions	ANSI Control Codes (Hex 0 to 1F)

NOTE

The ALT, CTRL and SHIFT-CTRL modes may be modified by the "Protected Keyboard Function" in the configuration mode. See Section 4 for more information.

Appendix A contains keyboard diagrams for all countries. Use these diagrams to determine the functions assigned to each key. Use key code lists in Appendix C for the codes generated when each key is pressed.

6.4 TERMINAL ADJUSTMENTS

Figure 6-4 shows the location of keys used to make terminal adjustments for the convenience of the operator. Follow the procedure below to make an adjustment:

1. Refer to Table 6-3 for a description of each convenience feature and how to activate it.
2. Locate the attribute to be modified on the labelled keystrip directly above the alphanumeric group of keys.
3. Press the **ALT** key (or the **ALT** and **CTRL** keys if **ALT** keys are protected) while simultaneously pressing the key beneath the label for the chosen feature. Execute the adjustment according to the instructions in Table 6-3.

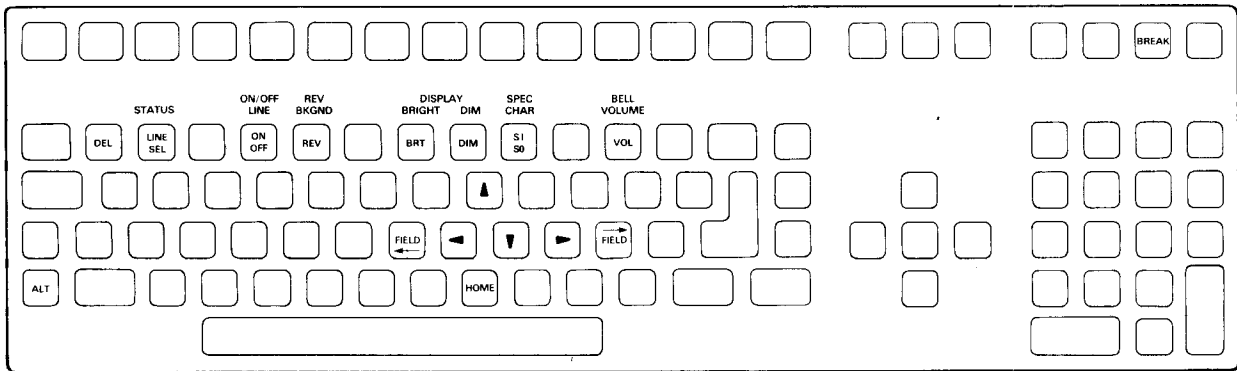

2229228-21

Figure 6-4. Keyboard - Alternate Selection

Table 6-3. Model 931 VDT Terminal Adjustments

Selection	Action	Results
STATUS	Press the ALT and 2 keys simultaneously.	Status line is blanked from view. The host CPU can still display messages on the status line.
	Repeat.	Status line is restored.
ON/OFF LINE	Press the ALT and 4 keys simultaneously.	Terminal goes offline. At power-up, terminal defaults to online.
	Repeat.	Terminal comes online.
REV BKGND	Press the ALT and 5 keys simultaneously.	Illuminated characters on a dark screen is the normal mode at power-up. Display changes to dark characters on an illuminated screen.
	Repeat.	Display returns to original condition.
DISPLAY BRIGHT	Press the ALT and the 7 key simultaneously to increase brightness one level.	There are sixteen levels of brightness. When you reach the highest brightness level, pressing the 7 key makes no further brightness increments.
		Press and hold the 7 key to advance through the sequence automatically.
DISPLAY DIM	Press the ALT and the 8 key simultaneously to decrease the brightness one level.	Continue to press the 8 key until you reach the desired level. When you reach the lowest level, pressing the 8 key makes no further decrements in brightness. Hold the 8 key to advance through the sequence automatically.
BELL VOLUME	Press the ALT key and the minus (–) key simultaneously to increase volume.	Four levels are available for the alarm: none, soft, medium, and loud. Each time the volume is increased, the alarm sounds at the new volume. If the volume is at the loudest level when the advance is made, the sequence starts over from the beginning.
	Press and hold the minus (–) key to advance through the sequence automatically.	

NOTE

If **ALT** keys are protected (see Section 4), press the **ALT** and the **CTRL** keys to perform these functions.

6.5 ESTABLISHING COMMUNICATIONS

The Model 931 VDT powers up in the online mode. In most hardwired and fiber optics applications, communication is established automatically and the Comm port message on the status line reads "Rdy." For remote applications using modems, the host must be called and modem communication procedures used. When the modem link is established, the status line reads "Rdy."

When online, the terminal and host computer perform a protocol exchange that establishes communications. Messages on the status line reflect the state of the protocol exchange and do not require further action unless communication cannot be established. If communication fails, record the status messages and refer to Section 7, "Diagnostics."

6.6 CARE AND CLEANING

WARNING

Always turn the power off and disconnect the power cord from the power source before you clean the terminal. If you do not do this, you can receive a fatal electric shock.

6.6.1 Display Screen

To clean the video display screen, use a soft, clean cloth dampened with glass-cleaning fluid. Gently wipe the screen.

6.6.2 Other Exterior Surfaces

Use a soft, clean cloth dampened with a mild soapy solution to clean exterior surfaces of the keyboard and video display terminal.

Diagnostics

7.1 INTRODUCTION

This section provides troubleshooting and diagnostic information for the Model 931 VDT. The General Troubleshooting Guide (Subsection 7.2) describes procedures for the terminal operator. The Internal Diagnostics (Subsection 7.3) provides a description of the internal diagnostic capabilities for those who have the systems level expertise to isolate a faulty component.

NOTE

Texas Instruments grants permission for the reproduction and distribution of Section 7. Information in Section 7 may also be incorporated into any auxiliary user documentation generated.

7.2 GENERAL TROUBLESHOOTING GUIDE

The Model 931 VDT has been designed with an internal set of diagnostic aids and utilities. These diagnostics provide the operator a means to ensure the integrity of the terminal. This allows the operator to rapidly isolate a problem, correct it, and return the terminal to use. If service is required, the results of the diagnostic tests are used by the customer representative to speed the repair process.

7.2.1 Self-Tests

The Model 931 VDT performs an internal self-test on critical circuits every time it is powered on. If any of the circuits are defective, an error message appears in the lower left corner of the display. These error messages are defined in Table 7-1.

If a message listed in the table is displayed, record it and notify service personnel. The terminal should not be returned to use until the problem is corrected. If no message is reported but the terminal does not function, proceed to paragraph 7.2.2, "Identifying Malfunction Categories."

Table 7-1. Terminal Error Messages

BTY FAILURE

The terminal's internal battery has failed. Configuration settings have been reset to factory default values. Contact Texas Instruments service, and report "Model 931 Battery Failure."

NOTE

A terminal with a battery failure may be used, but it will have to be reconfigured each time power is cycled.

ROM FAILURE

The terminal has an internal hardware failure. Call Texas Instruments service, and report "Model 931 ROM Failure."

RAM FAILURE

The terminal has an internal hardware failure. Call Texas Instruments service, and report "Model 931 RAM Failure."

KBD ERROR

The keyboard has failed to report results of its self-test to the video display unit. Make sure the keyboard cable is properly installed. Cycle power on the terminal. If the problem remains, call Texas Instruments service, and report "Model 931 Keyboard Error."

KBD FAILURE

The keyboard has failed its self-test. Call Texas Instruments service, and report "Model 931 Keyboard Failure."

7.2.2 Identifying Malfunction Categories

Not all problems can be diagnosed by internal self-tests. If your terminal does not record a self-test error message, identify the malfunction by another method. Follow the simple procedures outlined below to isolate and correct most problems with the Model 931 VDT.

To locate the problem, you need to answer three questions. Each question refers you to a simple troubleshooting routine to help you find the problem.

Is the display blank?

Yes

Go to paragraph 7.2.3, "Blank Screen Diagnosis."

Is the host computer responding to operator input?

No

Go to paragraph 7.2.4, "Communications Diagnosis."

Does the attached printer work properly?

No

Go to paragraph 7.2.5, "Printer Diagnosis."

7.2.3 Blank Display Diagnosis

Press any key.

Does the display appear?

Yes

The terminal has been idle for more than 15 minutes. The Model 931 VDT blanks the screen after 15 minutes of inactivity to prolong the life of the display phosphor. If this feature is undesirable, have your systems manager refer to Section 4, "Configuration," to disable the *Video Timer* selection. Return the terminal to active use.

No

Press and hold the **ALT** key (or the **CTRL** and **ALT** keys if in protected **ALT** key mode) and the **7** key simultaneously.

Does the display appear?

Yes

The terminal brightness has been adjusted too low for ambient lighting conditions. In rare cases, the internal electronics of the terminal need adjustment. A terminal in this condition does not require service unless the maximum brightness is too dim for comfort. Return the terminal to active use.

No

Examine the fault isolation indicators at the rear of the terminal. Refer to Figure 7-1, which shows the location of the indicators in the terminal with the inset showing their side-by-side arrangement. The rightmost (arrowed) indicator (Power Good LED) is green, and is lit in a normally functioning terminal.

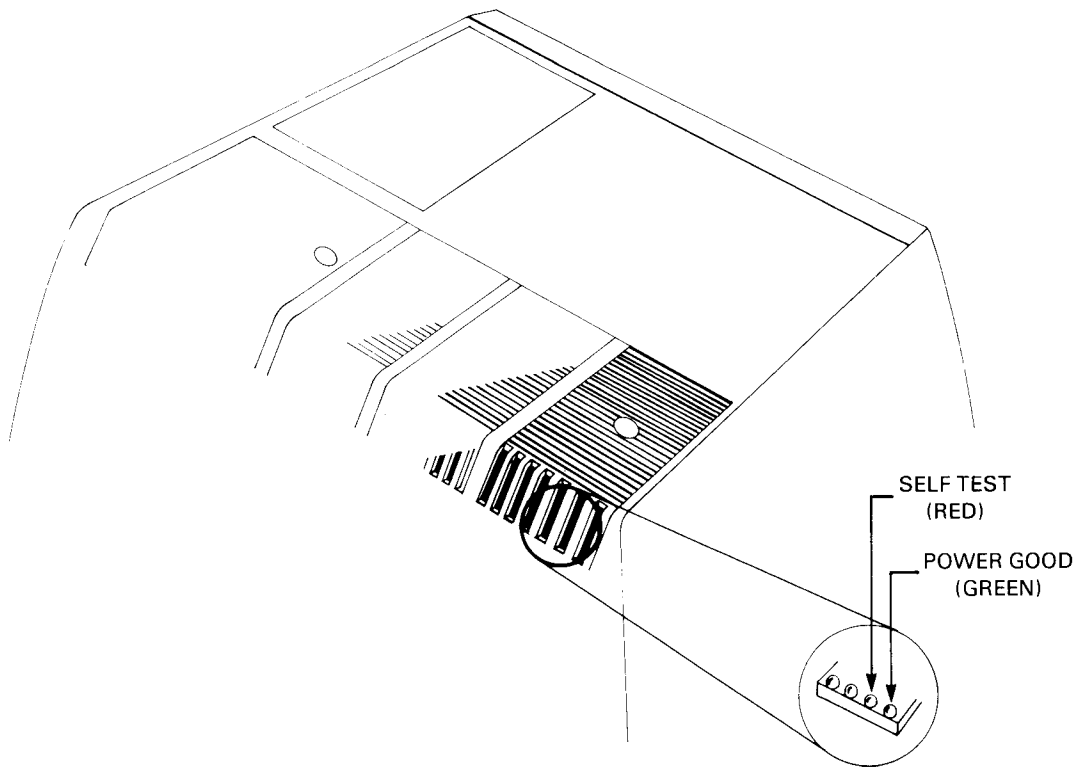

2229228 22

Figure 7-1. Fault Isolation Indicators — Self-Test and Power Good LEDs

Is the power good LED lit?

Yes

Go to paragraph 7.2.4, “Communications Diagnosis.”

No

The terminal is not receiving power. Perform the following steps to isolate the problem:

1. Make sure the power switch on the front of the terminal is ON (1).
2. Make sure the terminal and wall outlet power connections are secure.
3. Verify that the wall outlet is providing ac power. If it is not, contact a qualified electrician.

4. Check and replace the terminal fuse if necessary.
 - a. To locate the power fuse, face the back of the terminal. The fuse is located to the right of the power cord connector (see Figure 2-6).
 - b. Set the power switch to off and disconnect the ac power cord.
 - c. Release the fuse holder by turning the head of the fuse housing one quarter turn counterclockwise with a small screwdriver.
 - d. Withdraw the holder and inspect the fuse. Replace it if the filament is severed. Refer to Figure 7-2 to determine if the fuse is blown. For domestic terminals, replace a blown fuse with a Bel 3AG, 1 1/2 A, 250 V or Bel equivalent. For international terminals, use a metric 5 X 20 mm 1.0 A fuse, TI Part No. 2220531-0001.

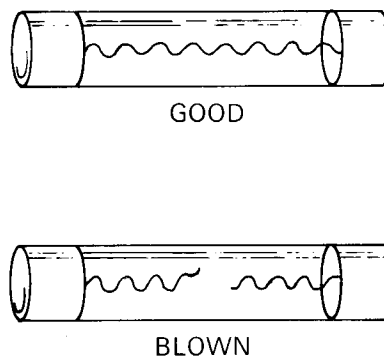

2229228-23

Figure 7-2. Model 931 VDT Power Fuse Condition

- e. Return the fuse holder to the socket. With a small, flat-bladed screwdriver, push the holder in and turn it clockwise until it stays in place (one quarter turn).
 - f. Reconnect the ac power cord and set the power switch to ON (1).
5. If none of these steps returns the terminal to operation, contact Texas Instruments service and report that the terminal has a "Power Supply Failure."

7.2.4 Communications Diagnosis

If the host computer fails to respond to operator input, a communications diagnosis is desirable, but first verify that the communications interface cable is secure to the terminal. (The cable should be squarely seated on its connector and its locking screws should be secured.) Answer these questions to diagnose a communications problem:

Refer to the terminal status area, the leftmost message is either Onln or Offln.

Is the terminal online ?

No

Press the **ALT** (or **CTRL** and **ALT** keys if in protected ALT key mode) and **4** keys simultaneously. The status line message now displays *Online*. If host response resumes, return the terminal to service; otherwise, perform the next test.

Yes

Does the status line read DCD(1) DSR(1) Comm: Rdy?

No

The terminal is either configured incorrectly, or the problem is external to the terminal. If the fiber optics communications option is being used, the terminal must be configured to activate it (see paragraph 4.3.2, "Comm Port Selection"). Contact your systems manager to configure the terminal.

If the terminal does not return to service with the adjustments made so far, examine the fault isolation indicators at the rear of the terminal. The location of these indicators in the terminal is shown in Figure 7-1. Figure 7-3 shows the side-by-side locations of the transmit and receive LEDs.

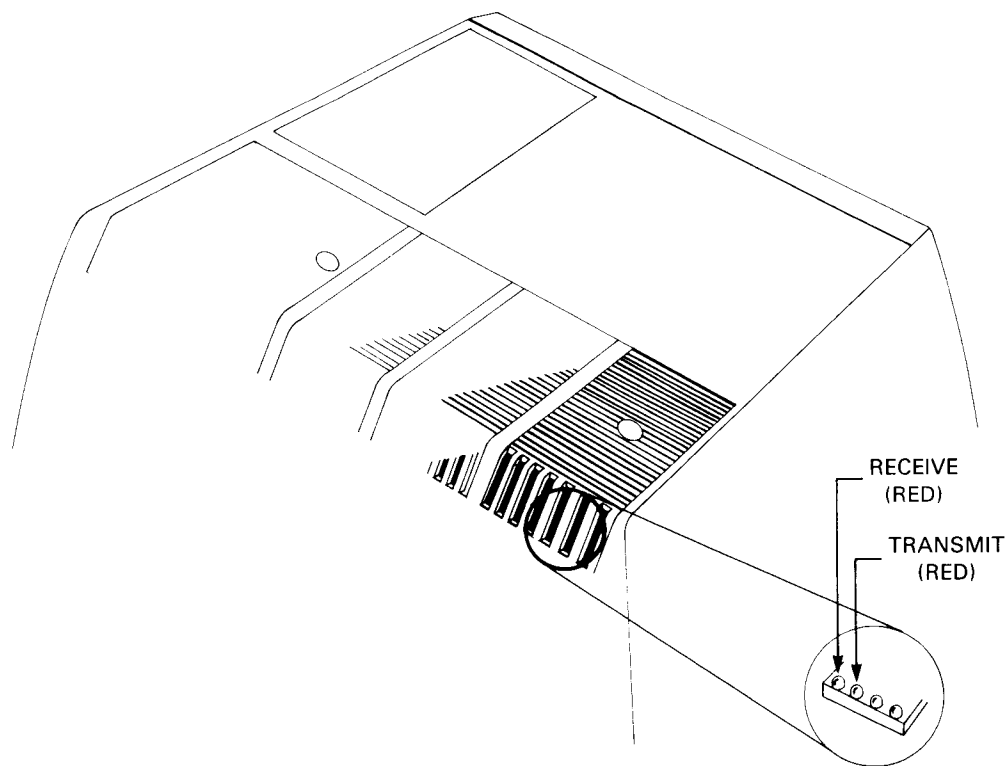

2229228-24

Figure 7-3. Fault Isolation Indicators — Transmit and Receive LEDs

The Transmit Data and Receive Data LEDs are both red. The transmit LED flashes as data is transmitted to the host. The receive LED flashes as data is received from the host. In normal operation, both indicators should flash briefly as keys are typed.

Does only the transmit data indicator flash?

Yes

Contact your systems manager, because the problem is external to the terminal.

Do both the transmit and receive data indicators flash?

Yes

Contact your systems manager, because the problem is external to the terminal.

No

Contact Texas Instruments service and report a "Communications Failure."

7.2.5 Printer Diagnosis

This section helps you isolate problems with a printer attached to the Model 931 VDT.

First, verify that the interface cable between the Model 931 terminal and the attached printer are secured. Both ends of the cable should be squarely seated on the connector and the locking screws should be secured.

Is the printer online? (Refer to the printer's operational instructions if necessary.)

No

Set the printer online. If the printer resumes operation, return the terminal to service.

Is the printer jammed or out of paper?

Yes

Reload the paper. If the printer resumes normal operation, return the terminal to service.

Does the status line read: Aux:Busy?

Yes

Note that the status line message usually alternates between *Rdy* and *Busy* while the printer is printing data. However, the *Busy* message should not persist for more than a few minutes. If it does, contact your systems manager to verify the terminal's Auxiliary configuration parameters (refer to paragraph 4.4.1).

Does the status line read: Aux:Off?

Yes

Contact your systems manager to verify the terminal's Aux configuration parameters. Refer to paragraph 4.4.1.

Does the status line read: Aux: Rdy?

Yes

Contact your systems manager to verify the terminal's Aux configuration parameters. Refer to paragraph 4.4.1. Pressing the **PRINT** key while in the configuration mode causes the Model 931 VDT to print the configuration parameters on the attached printer. This feature verifies the operation of the terminal to printer interface.

If none of the foregoing procedures returns the printer to operation, contact Texas Instruments service and report "Model 931 will not print."

7.3 INTERNAL DIAGNOSTICS

This section describes the internal diagnostic tests for the Model 931 VDT. These tests are used to establish the integrity of the terminal if multiple system components are suspected of failure.

These tests may be initiated from the terminal keyboard or by commands from the host computer (see paragraph 5.14).

To perform the internal diagnostics, place the terminal in the configuration mode. The configuration mode can be entered when the terminal is either online or offline. Host communications are suspended while the terminal is in this mode.

To enter the configuration mode, simultaneously press the **ALT** key, **SHIFT** key, and the **BACKSPACE** key. The first menu appears on the status line:

Config: Comm Aux Dsply Keybd Diag

To enter the Diagnostic (Diag) Test Menu:

1. Press the **TAB** or **RIGHT ARROW** key to move the underscore to the right. If the underscore is beneath the last entry on the right, pressing the **TAB** or **RIGHT ARROW** key returns the underscore to the first (left) selection. (Underscore wraps right to left.)
2. Press the **SHIFT** and **TAB** keys or the **LEFT ARROW** key to move the underscore to the left. If the underscore is beneath the first (left) entry, pressing the **SHIFT** and **TAB** (or the **LEFT ARROW**) keys returns the underscore to the last entry on the right. (Underscore also wraps left to right.)
3. Using these controls, move the underscore to Diag on the Config menu.
4. Press the **RETURN** or **DOWN ARROW** key. The status line now displays the Diagnostic Execute menu:

Diag Execute: Rom Ram N-V Ram B-Pole Pattern Factory
5. Select the required Diagnostic Task from the Diagnostic Execute menu (you may want to run all tests) by pressing the **TAB** or the **RIGHT ARROW** key to move the underscore and highlight to the right. Press the **SHIFT** key and the **TAB** key simultaneously or the **LEFT ARROW** key to move the underscore and highlight to the left.
6. Press the **ENTER** key to execute a selected test. (Tests are listed in the paragraphs following these instructions.)
7. Record and date test results for reference.
8. Press any key on the keyboard when you are ready to exit the test and re-enter the Diagnostic menu.
9. Exit the configuration mode by simultaneously pressing the **ALT** key, the **SHIFT** key, and the **BACKSPACE** key.

7.3.1 ROM (Read Only Memory) Test

This test verifies the terminal's program storage ROMs. The results of the test are displayed on the status line as a version number, revision level, Texas Instruments part number and a "P" or "F" for each ROM installed in the terminal. A "P" indicates the device passed the test; an "F" indicates the device failed. If any device fails, the terminal should be removed from service until the problem is corrected.

7.3.2 RAM (Random Access Memory) Test

This test verifies the terminal's internal RAM. The results of the test are displayed on the status line as "RAM Test Passed" for a successful test, or "RAM FAILURE" for an unsuccessful test. If this test fails, the terminal should be removed from service until the problem is corrected.

7.3.3 N-V RAM (Non-Volatile RAM) Test

This test verifies the terminal's battery backed-up parameter storage RAM. The results of the test are displayed on the status line as "Passed NV-RAM Test" for a successful test, "NV-RAM FAILURE" for an unsuccessful test. If this test fails, the terminal should be removed from service until the problem is corrected.

Do not confuse a failure message for this test with the "BTY FAILURE" message that may be displayed at power-up. The "BTY FAILURE" message occurs when the contents of the N-V RAM are incorrect, but can be successfully reset to factory default values. With an "N-V RAM FAILURE," factory default values cannot be restored because of hardware failure.

7.3.4 B-Pole Test

This test fills the display with characters. All character and attribute combinations are displayed. Compare the display with Figure 7-4. If some characters are absent or shaped incorrectly, call service and report a "B-pole Test Failure."

7.3.5 Pattern

This test fills the display with uppercase "O" characters. Use this pattern to adjust the brightness of the screen. Press the ALT key (or the ALT and CTRL keys if in protected ALT key mode) and the 7 key to increase, or the 8 key to decrease, brightness.

7.3.6 Factory

This test causes the terminal to execute continuously all of the foregoing tests as well as a loopback test of both the EIA and Fiber Optics (if installed) interfaces.

This test begins to execute when the configuration mode is exited and remains active until the mode is entered once again. The test remains active even when the power is cycled off, then on. If any test fails, the standard message appears and the test terminates.

NOTE

This test is designed for Texas Instruments factory and service representative use only. It requires special loopback plugs to be installed in the comm EIA port and if installed, the fiber optic port. Executing this test without these plugs causes the test to fail.

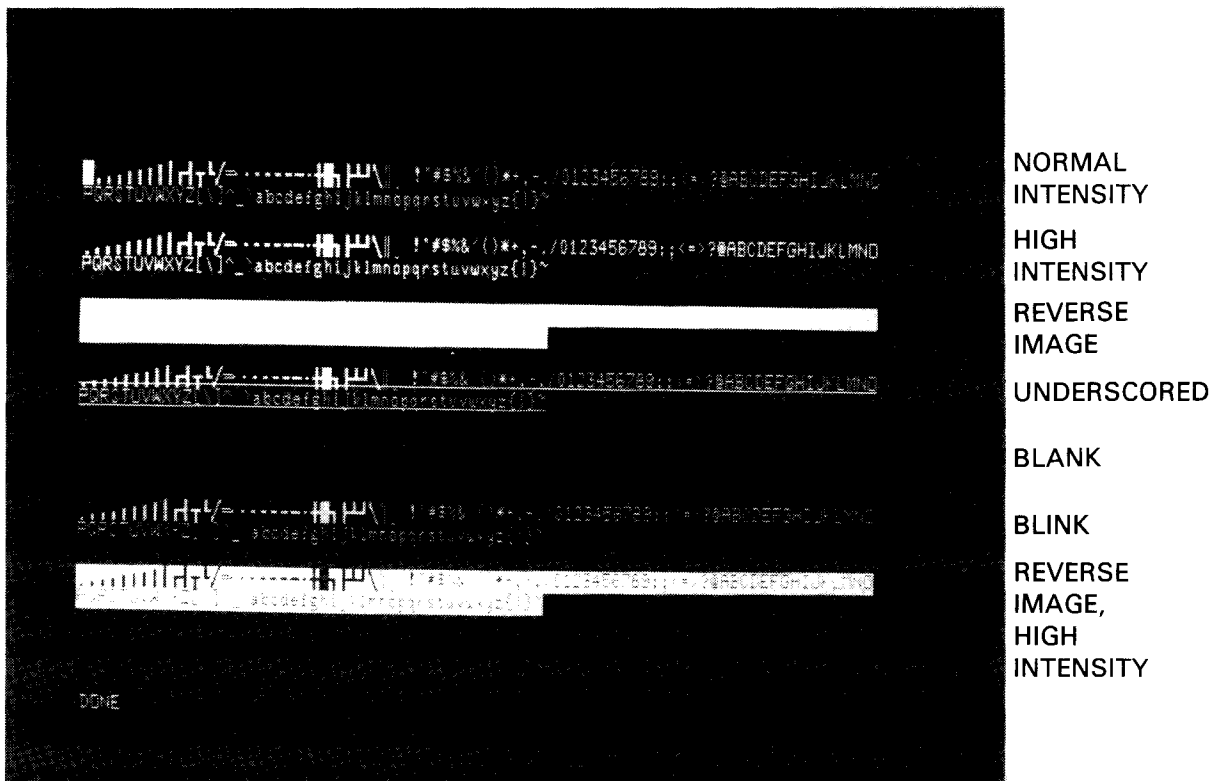

Figure 7-4. B-Pole Test Pattern

2229228-25

7.3.7 Loopback Test

This test verifies that the terminal both transmits and receives data. In normal operation, data is transmitted from the Model 931 VDT to the host computer, which echoes the data and transmits commands that control the terminal display. In the loopback mode, the input and output of the terminal are directly connected. Data normally transmitted to the host is displayed instead.

To activate the loopback test, press the **DOWN ARROW** key from any position in the Diag Execute menu. The status line displays:

Diag Loopback: Off On

Select *On* from the Loopback menu and press the **ENTER** key. The status line displays "DONE." The test activates when the configuration mode is exited.

To exit the loopback test mode, re-enter the configuration mode and select the Diag Loopback menu. The status line now displays:

Diag Loopback: Off On

Select *Off* and press the **ENTER** key.

NOTE

Use only the 96 displayable ASCII keyboard characters for this test or activate the keyboard test mode at the same time the loopback test mode is selected.

7.3.8 Keyboard Test

This test disables the Model 931's internal key mapping function. When pressed, each key generates a two-character ASCII data code as defined in Appendix C, "Key Codes."

If the terminal is online, these codes are sent to the host. If the terminal is offline, they are displayed. This helps you verify that each key is operating correctly.

To activate the keyboard test mode, select:

Diag Keybd Test: Off On

Press the **ENTER** key. The test becomes active when you exit the configuration mode.

To terminate the test, re-enter the configuration mode, and select:

Diag Keybd Test: Off On

Press the **ENTER** key.

7.3.9 Reset

This resets the Model 931 VDT configuration parameters to their factory default values. See Subsection 5.13 for factory default values.

This command should be used only by persons with systems expertise.

Diag Reset: No Yes

Select **Yes** and press the **ENTER** key to perform the reset command.

7.4 ONLINE CONFIDENCE TESTS

The Model 931 VDT can be tested using the diagnostic capabilities of the host CPU in conjunction with the diagnostic commands described in paragraph 5.14. These commands allow initiation of diagnostic routines that do not require the participation of the Model 931 operator.

Appendix A

International Keyboards

A.1 INTRODUCTION

The Model 931 VDT is available with international keyboards in addition to the US standard keyboard. These are all of the available keyboards:

- United States
- Danish/Norwegian
- French Data Processing
- French Word Processing
- German/Austrian
- Spanish
- Swedish/Finnish
- Swiss
- United Kingdom

Figures A-1 through A-9 show the following:

- The keyboard layouts for each country
- The ASCII codes transmitted from the keyboard for each character
- The special character set (SC2) of 32-line drawing characters available with each keyboard

In these figures, the keyboard is at the top of the page. The ASCII codes for the primary character set are below and to the left. The SC2 line drawing character set is below and to the right.

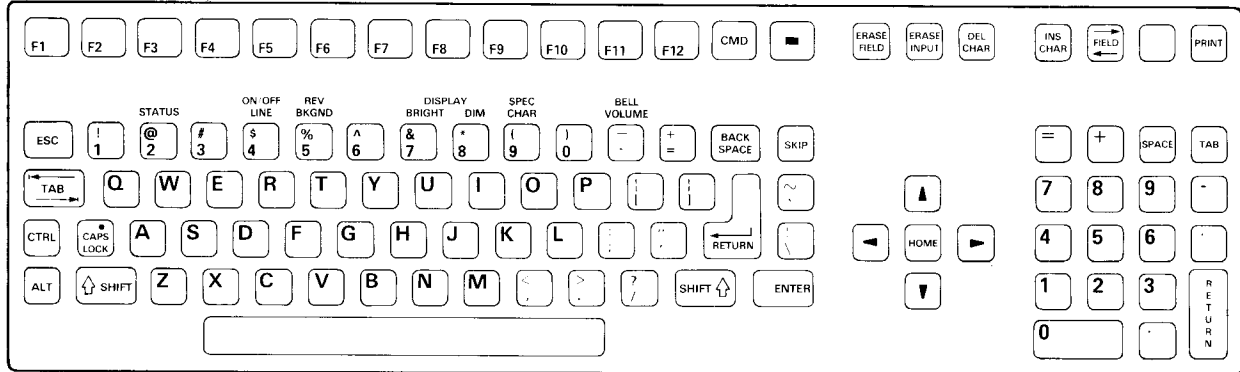

2229228-26

MSB \ LSB	0	1	2	3	4	5	6	7
0			SP	0	@	P	,	p
1			!	1	A	Q	a	q
2			'	2	B	R	b	r
3			#	3	C	S	c	s
4			\$	4	D	T	d	t
5			%	5	E	U	e	u
6			&	6	F	V	f	v
7			'	7	G	W	g	w
8			(8	H	X	h	x
9)	9	I	Y	i	y
A		↓	*	:	J	Z	j	z
B			+	;	K	[k	{
C			,	<	L	\	l	
D			-	=	M]	m	}
E			.	>	N	^	n	~
F			/	?	O	_	o	

2229228-27

MSB \ LSB	0	1	2	3	4	5	6	7
0								
1								
2								
3								
4								
5								
6								
7								
8								
9								
A								
B								
C								
D								
E								
F								

2229228-28

Figure A-1. United States Keyboard and Character Sets

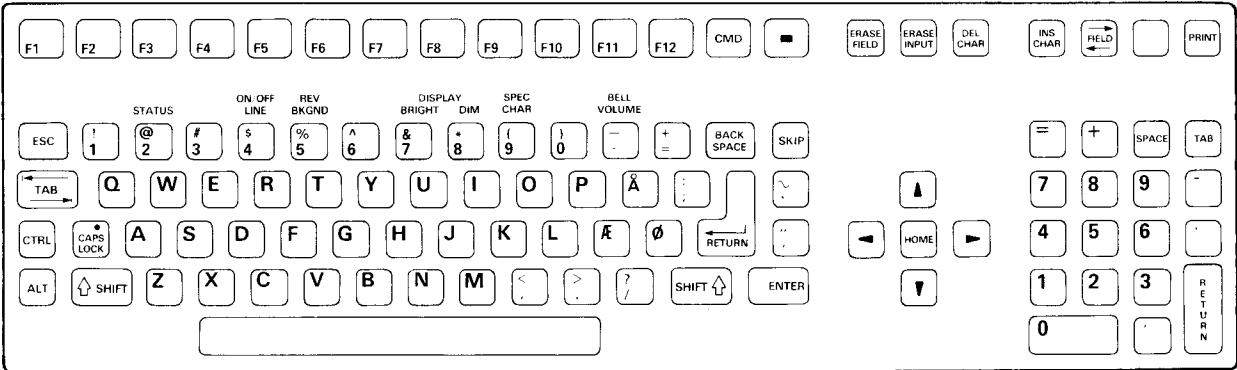

2229228-29

MSB \ LSB	0	1	2	3	4	5	6	7
0			SP	0	@	P	'	p
1			!	1	A	Q	a	q
2			"	2	B	R	b	r
3			#	3	C	S	c	s
4			\$	4	D	T	d	t
5			%	5	E	U	e	u
6			&	6	F	V	f	v
7			'	7	G	W	g	w
8			(8	H	X	h	x
9)	9	I	Y	i	y
A			*	:	J	Z	j	z
B			+	;	K	Æ	k	æ
C			,	<	L	Ø	l	ø
D			-	=	M	Å	m	å
E			.	>	N	^	n	~
F			/	?	O	_	o	

2229228-30

MSB \ LSB	0	1	2	3	4	5	6	7
0								
1								
2								
3								
4								
5								
6								
7								
8								
9								
A								
B								
C								
D								
E								
F								

2229228-28

Figure A-2. Danish/Norwegian Keyboard and Character Sets

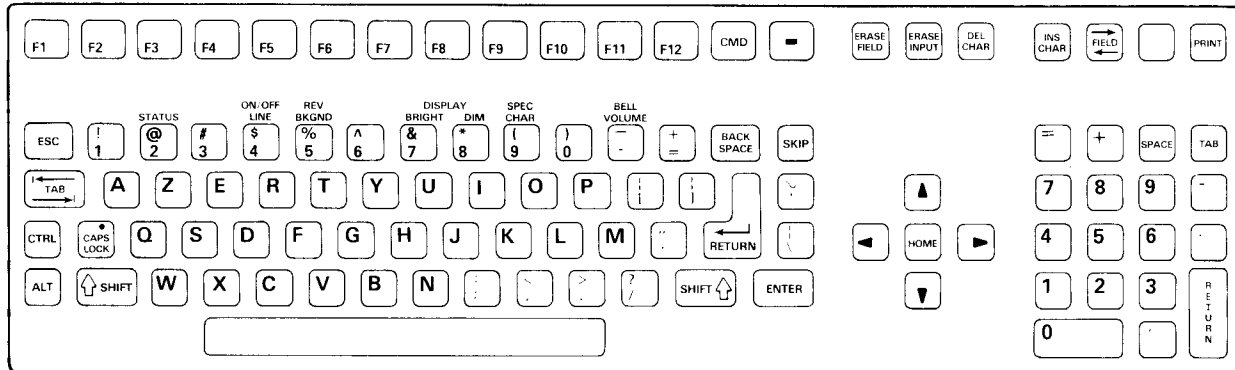

2229228-31

MSB \ LSB	0	1	2	3	4	5	6	7
0			SP	0	@	P	'	p
1			!	1	A	Q	a	q
2			"	2	B	R	b	r
3			#	3	C	S	c	s
4			\$	4	D	T	d	t
5			%	5	E	U	e	u
6			&	6	F	V	f	v
7			'	7	G	W	g	w
8			(8	H	X	h	x
9)	9	I	Y	i	y
A		↓	*	:	J	Z	j	z
B			+	;	K	[k	{
C			,	<	L	\	l	
D			-	=	M]	m	}
E			.	>	N	^	n	~
F			/	?	O	_	o	

2229228-27

MSB \ LSB	0	1	2	3	4	5	6	7
0								
1								
2								
3								
4								
5								
6								
7								
8								
9								
A								
B								
C								
D								
E								
F								

2229228-28

Figure A-3. French Data Processing Keyboard and Character Sets

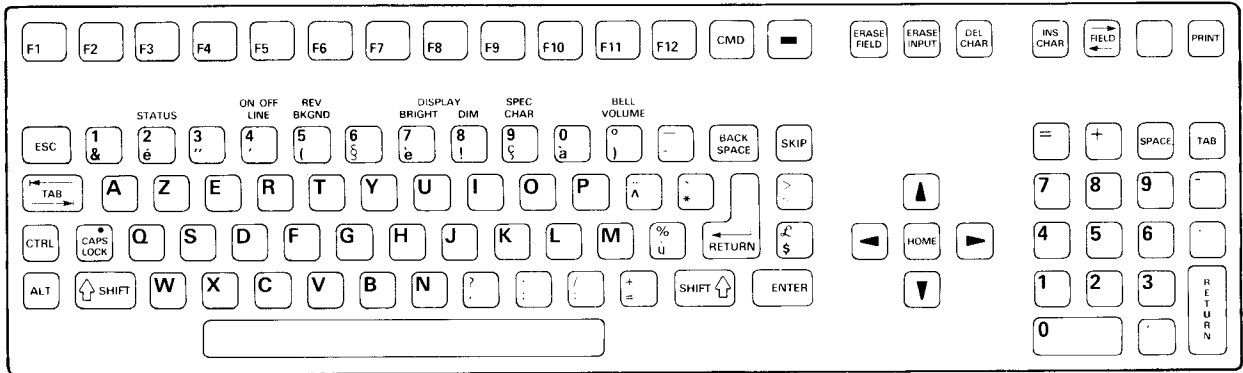

2229228-32

MSB \ LSB	0	1	2	3	4	5	6	7
0			SP	0	à	P	'	p
1			!	1	A	Q	a	q
2			"	2	B	R	b	ř
3			£	3	C	S	c	s
4			\$	4	D	T	d	t
5			%	5	E	U	e	u
6			&	6	F	V	f	v
7			'	7	G	W	g	w
8			(8	H	X	h	x
9)	9	I	Y	i	y
A		↓	*	:	J	Z	j	z
B			+	;	K	°	k	é
C			,	<	L	ç	l	ù
D			-	=	M	§	m	è
E			.	>	N	^	n	..
F			/	?	O	—	o	

2229228-33

MSB \ LSB	0	1	2	3	4	5	6	7
0								
1								
2								
3								
4								
5								
6								
7								
8								
9								
A								
B								
C								
D								
E								
F								

2229228-28

Figure A-4. French Word Processing Keyboard and Character Sets

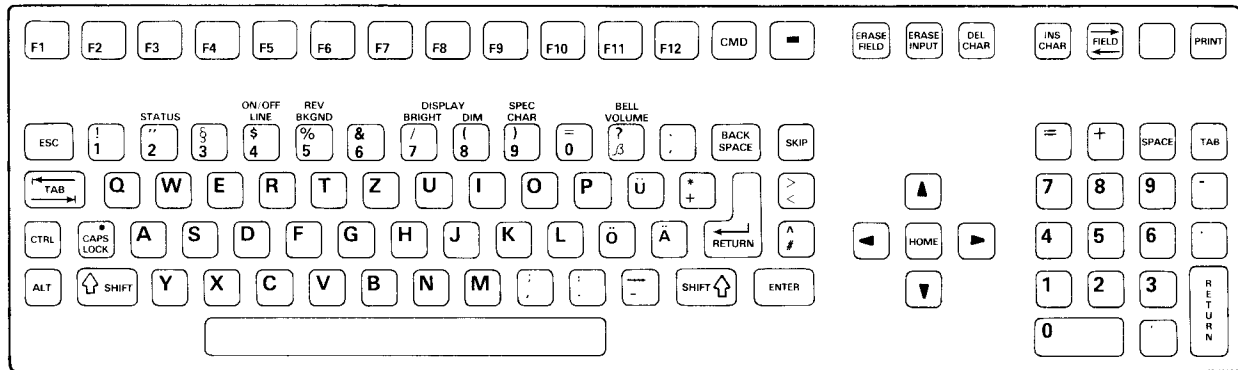

2229228-34

MSB \ LSB	0	1	2	3	4	5	6	7
0			SP	0	§	P	,	p
1			!	1	A	Q	a	q
2			"	2	B	R	b	r
3			#	3	C	S	c	s
4			\$	4	D	T	d	t
5			%	5	E	U	e	u
6			&	6	F	V	f	v
7			'	7	G	W	g	w
8			(8	H	X	h	x
9)	9	I	Y	i	y
A		↓	*	:	J	Z	j	z
B			+	;	K	Ä	k	ä
C			,	<	L	Ö	l	ö
D			-	=	M	Ü	m	ü
E			.	>	N	^	n	ß
F			/	?	O	_	o	

2229228-35

MSB \ LSB	0	1	2	3	4	5	6	7
0								
1								
2								
3								
4								
5								
6								
7								
8								
9								
A								
B								
C								
D								
E								
F								

2229228-28

Figure A-5. German/Austrian Keyboard and Character Sets

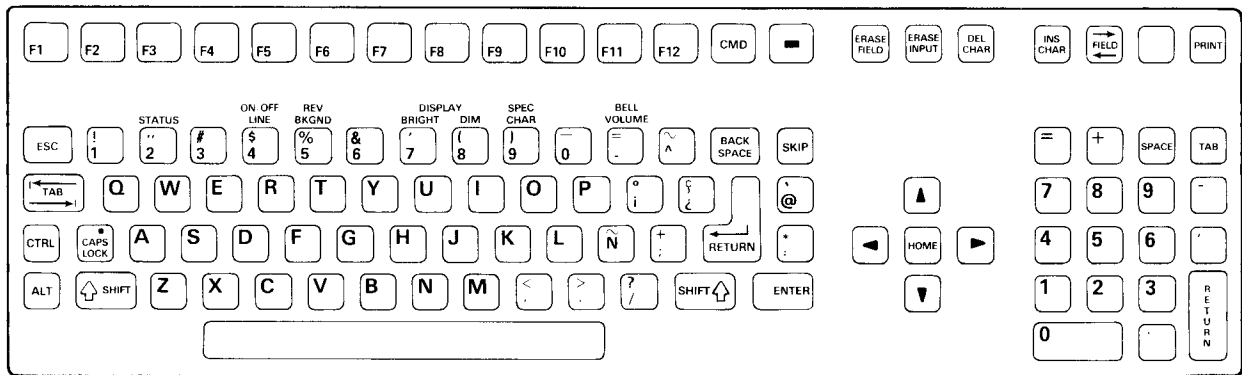

2229228-36

LSB	MSB	0	1	2	3	4	5	6	7
0				SP	0	@	P	'	p
1				!	1	A	Q	a	q
2				´	2	B	R	b	r
3				¸	3	C	S	c	s
4				\$	4	D	T	d	t
5				%	5	E	U	e	u
6				&	6	F	V	f	v
7				'	7	G	W	g	w
8				(8	H	X	h	x
9)	9	I	Y	i	y
A			↓	*	:	J	Z	j	z
B				+	;	K	I	k	º
C				,	<	L	Ñ	l	ñ
D				-	=	M	¿	m	ç
E				.	>	N	^	n	~
F				/	?	O	_	o	

2229228-37

LSB	MSB	0	1	2	3	4	5	6	7
0									
1									
2									
3									
4									
5									
6									
7									
8									
9									
A									
B									
C									
D									
E									
F									

2229228-28

Figure A-6. Spanish Keyboard and Character Sets

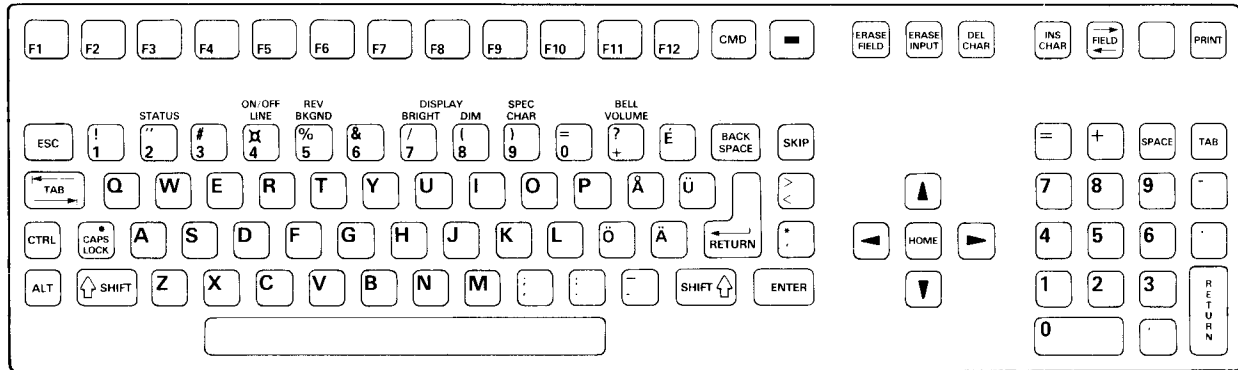

2229228-38

MSB \ LSB	0	1	2	3	4	5	6	7
0			SP	0	É	P	é	p
1			!	1	A	Q	a	q
2			"	2	B	R	b	r
3			#	3	C	S	c	s
4			Å	4	D	T	d	t
5			%	5	E	U	e	u
6			&	6	F	V	f	v
7			'	7	G	W	g	w
8			(8	H	X	h	x
9)	9	I	Y	i	y
A		↓	*	:	J	Z	j	z
B			+	;	K	Ä	k	ä
C			,	<	L	Ö	l	ö
D			-	=	M	Å	m	å
E			.	>	N	Ü	n	ü
F			/	?	O	—	o	

2229228-39

MSB \ LSB	0	1	2	3	4	5	6	7
0								
1								
2								
3								
4								
5								
6								
7								
8								
9								
A								
B								
C								
D								
E								
F								

2229228-28

Figure A-7. Swedish/Finnish Keyboard and Character Sets

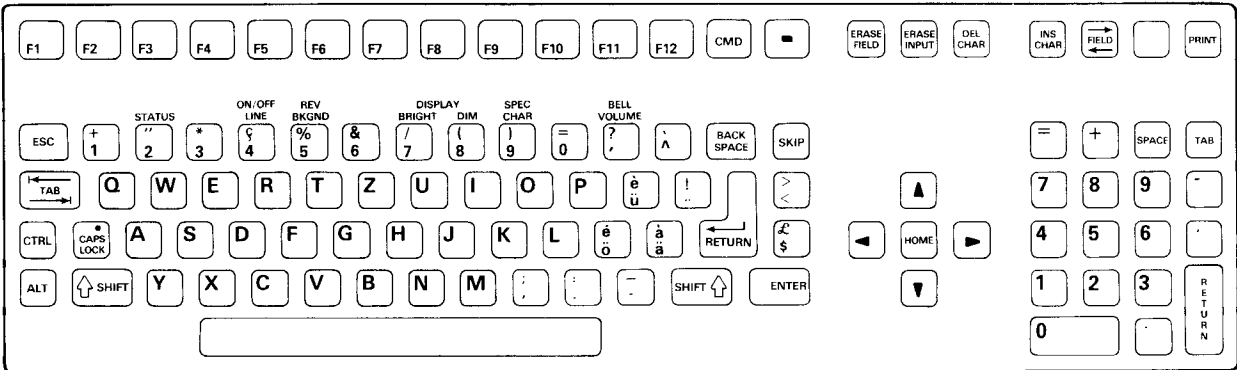

2229228-40

MSB	0	1	2	3	4	5	6	7
0			SP	0	á	P	'	p
1			!	1	A	Q	a	q
2			"	2	B	R	b	r
3			£	3	C	S	c	s
4			\$	4	D	T	d	t
5			%	5	E	U	e	u
6			&	6	F	V	f	v
7			'	7	G	W	g	w
8			(8	H	X	h	x
9)	9	I	Y	i	y
A		↓	*	:	J	Z	j	z
B			+	;	K	é	k	ä
C			,	<	L	ç	l	ö
D			-	=	M	è	m	ü
E			.	>	N	^	n	..
F			/	?	O	_	o	

2229228-41

MSB	0	1	2	3	4	5	6	7
0								
1								
2								
3								
4								
5								
6								
7								
8								
9								
A								
B								
C								
D								
E								
F								

2229228-28

Figure A-8. Swiss Keyboard and Character Sets

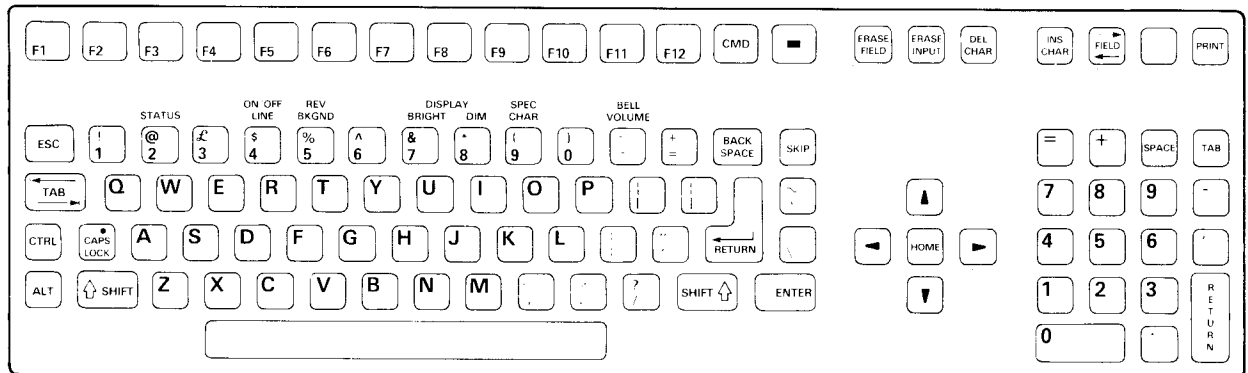

2229228-42

MSB \ LSB	0	1	2	3	4	5	6	7
0			SP	0	@	P	'	p
1			!	1	A	Q	a	q
2			"	2	B	R	b	r
3			£	3	C	S	c	s
4			\$	4	D	T	d	t
5			%	5	E	U	e	u
6			&	6	F	V	f	v
7			'	7	G	W	g	w
8			(8	H	X	h	x
9)	9	I	Y	i	y
A		↵	*	:	J	Z	j	z
B			+	;	K	[k	{
C			,	<	L	\	l	
D			-	=	M]	m	}
E			.	>	N	^	n	~
F			/	?	O	_	o	

2229228-43

MSB \ LSB	0	1	2	3	4	5	6	7
0								
1								
2								
3								
4								
5								
6								
7								
8								
9								
A								
B								
C								
D								
E								
F								

2229228-28

Figure A-9. United Kingdom Keyboard and Character Sets

A.2 Using the Keyboards

Four terminal functions can be performed at each keyboard:

- Data entry and editing
- Convenience adjustments
- Control functions
- Command functions

Blank keys have no assigned function and ring the bell when pressed.

A.2.1 Data Entry and Editing

The operator uses the following keyboard states for data entry and editing:

- Normal (**SHIFT** and **CAPS LOCK** keys not pressed)
- SHIFT (**SHIFT** key pressed)
- CAPS LOCK (**CAPS LOCK** key pressed)

Each state selects a set of alpha characters, numerals or symbols. Table A-1 indicates which characters, numerals and symbols are selected by using each state.

Table A-1. Data Entry and Editing

Keyboard State	Alpha Characters	Two-Label Keycaps	Cursor Control, Editing, and Special Function Keys
Normal (No shift)	Lowercase	Lower label	Yes
SHIFT	Uppercase	Upper label	Yes
CAPS LOCK	Uppercase	Lower label	Yes

Figure A-10 shows the character selections for the three states (Normal, SHIFT, CAPS LOCK) on the standard US keyboard. Data entry and editing are accomplished in a similar way using all other keyboards.

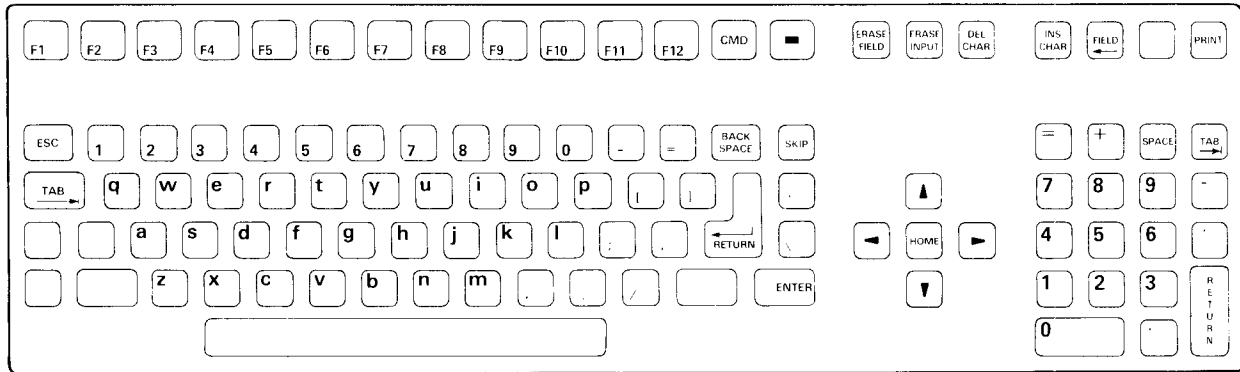

2229228-44

NORMAL

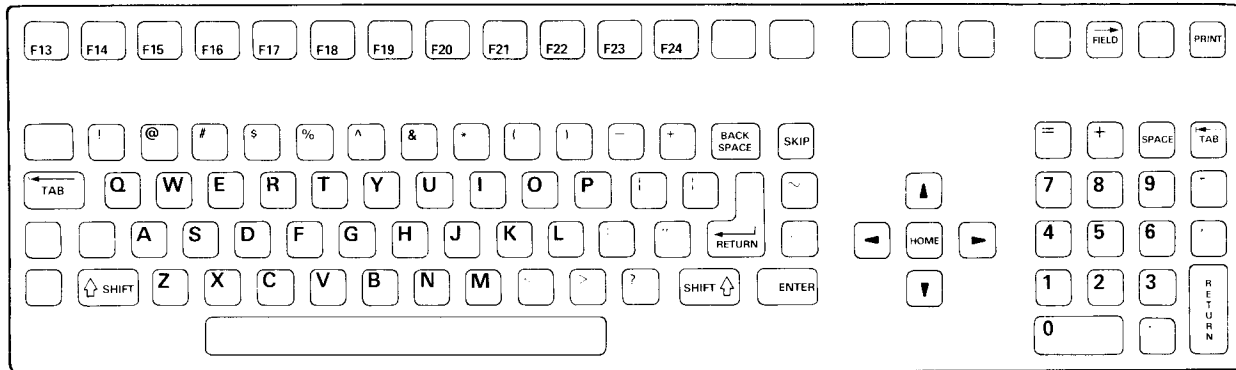

2229228-45

SHIFT

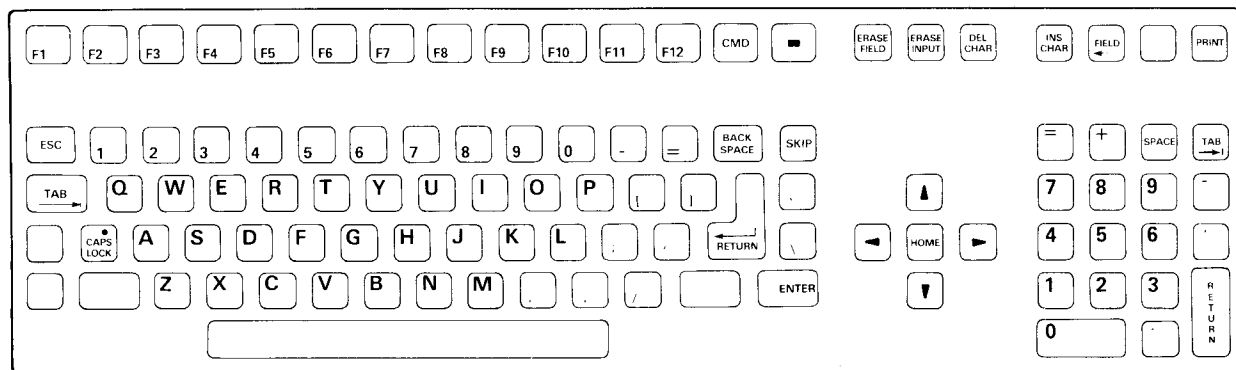

2229228-46

CAPS LOCK

Figure A-10. Data Entry and Editing — US Keyboard

A.2.2 Convenience Adjustments

By simultaneously pressing the proper mode key or keys as shown in Figure A-11 and the appropriate convenience adjustment key, the operator controls display features of the terminal. These features are reverse image, highlight, bell volume, brightness, and alphanumeric keypad cursor control. Refer to Figure A-11 to locate the key that activates each feature.

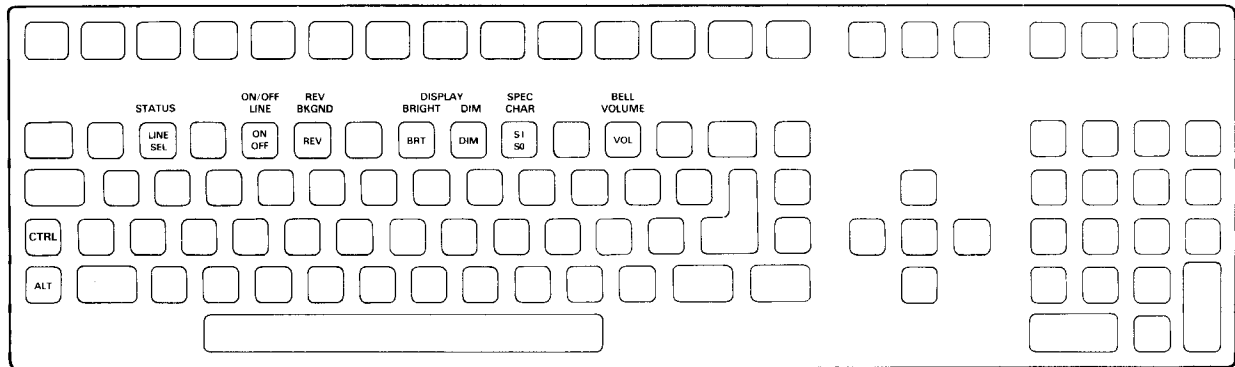

PROTECTED ALT-CTRL

2229228-54

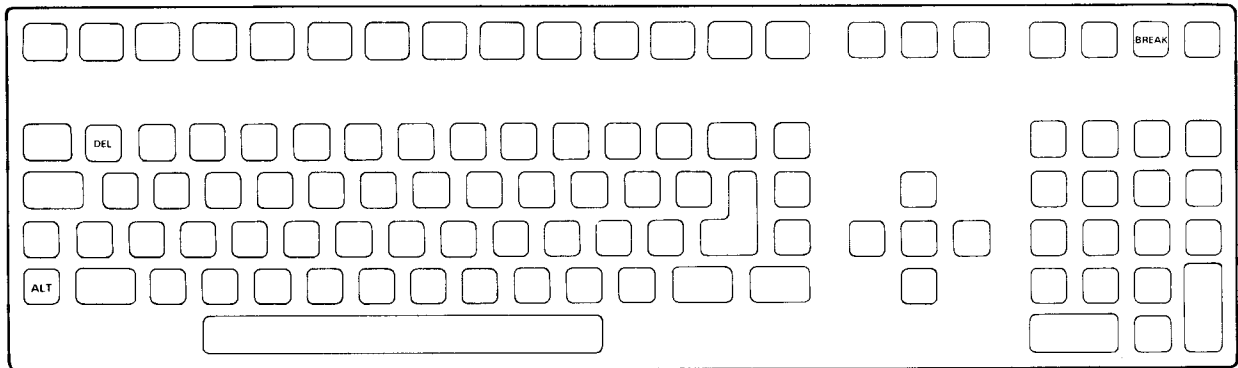

PROTECTED ALT

2229228-53

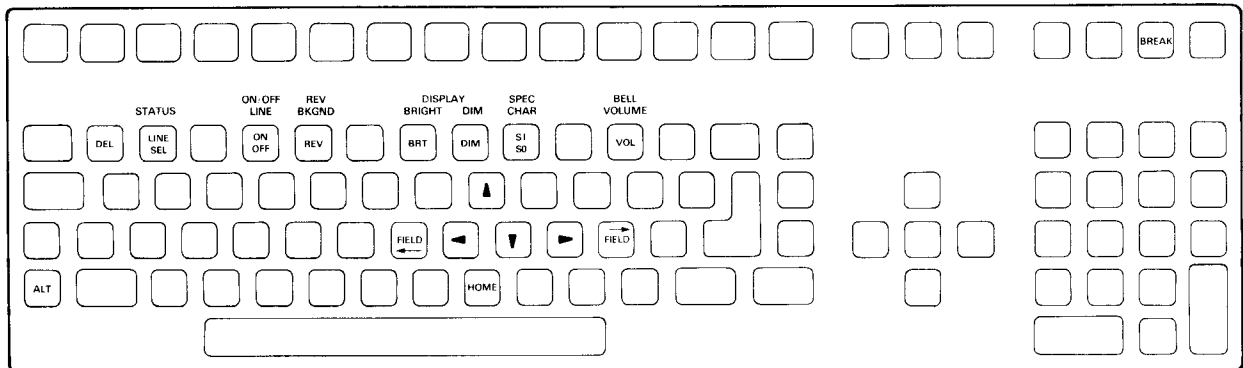

UNPROTECTED ALT

2229228-21

Figure A-11. Terminal Convenience Adjustment

A.2.3 Control Functions

By simultaneously pressing the **SHIFT** and **ALT** keys and the appropriate function key, the operator can perform the following control functions: blank the status line, cancel printer output, unlock the keyboard, and enter or exit the programmer configuration mode. Figure A-12 shows the keys that activate each function.

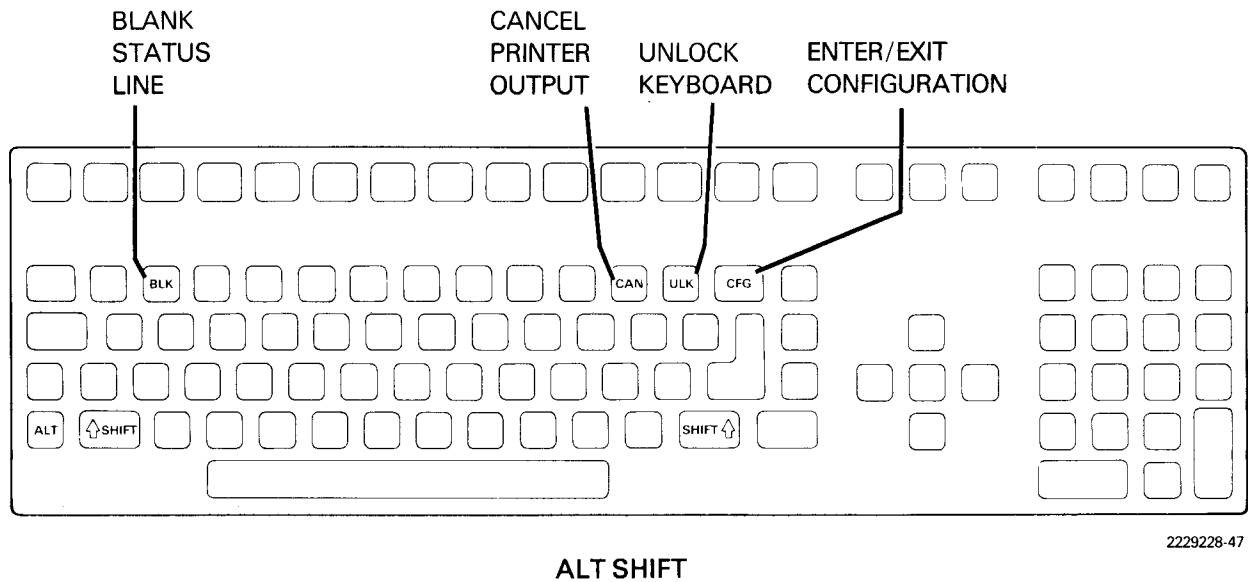

Figure A-12. Terminal Control Function Keyboard Mode

A.2.4 Control Code Functions

Refer to Table A-2 for the ANSI control codes accessed by the **CTRL** mode and the **SHIFT** and **CTRL** modes.

Table A-2. Terminal Command Functions

Keyboard State	Description	Commands
CTRL	ANSI Control Codes (ASCII Characters Hex 0 to 1F)	DC1, ETB, ENQ, DC2, DC4, EM, NAK, HT, SI, DLE, ESC, GS, SOH, DC3, EOT, ACK, BEL, BS, LF, VT, FF, SUB, CAN, ETX, SYN, STX, SO, CR, NUL, FS, CTR, LCK
SHIFT and CTRL	ANSI Control Codes (ASCII Characters Hex 0 to 1F)	DC1, ETB, ENQ, DC2, DC4, EM, NAK, HT, SI, DLE, ESC, GS, SOH, DC3, EOT, ACK, BEL, BS, LF, VT, FF, SUB, CAN, ETX, SYN, STX, SO, CR, NUL, FS, RS, US

Control code abbreviations are provided in Table B-2.

Figure A-13 shows the keys that activate each control code. To transmit a control code, press the appropriate key simultaneously with the control key (the **CTRL** key or the **SHIFT** and **CTRL** keys).

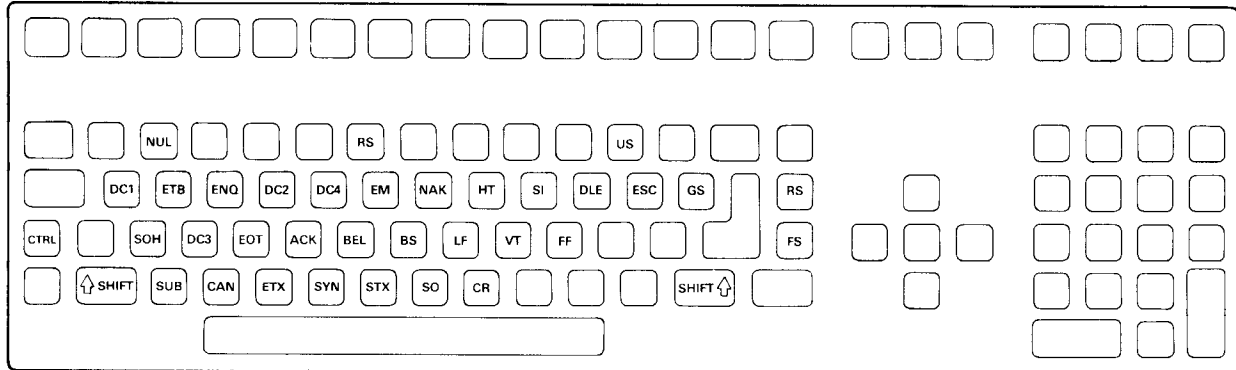

2229228-48

UNPROTECTED SHIFT CTRL

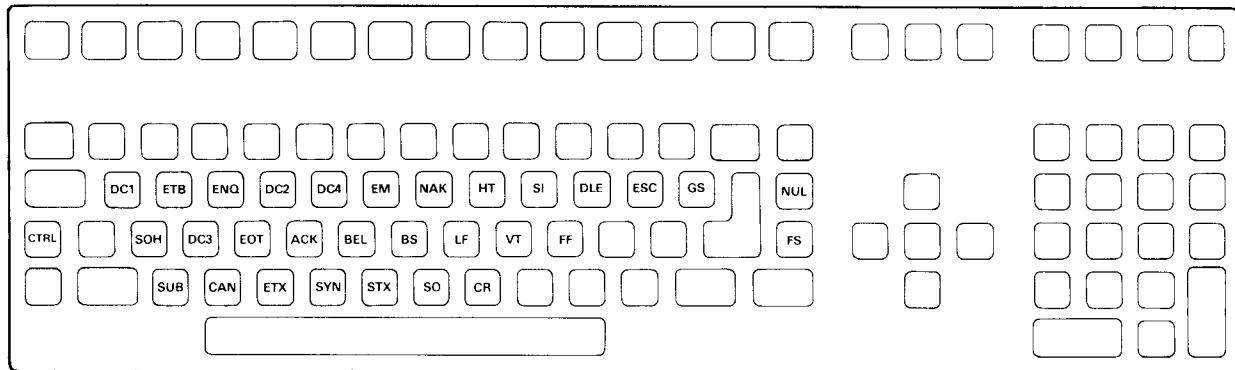

2229228-49

UNPROTECTED CTRL

Figure A-13. Terminal Control Code Keyboard Modes (Unprotected)

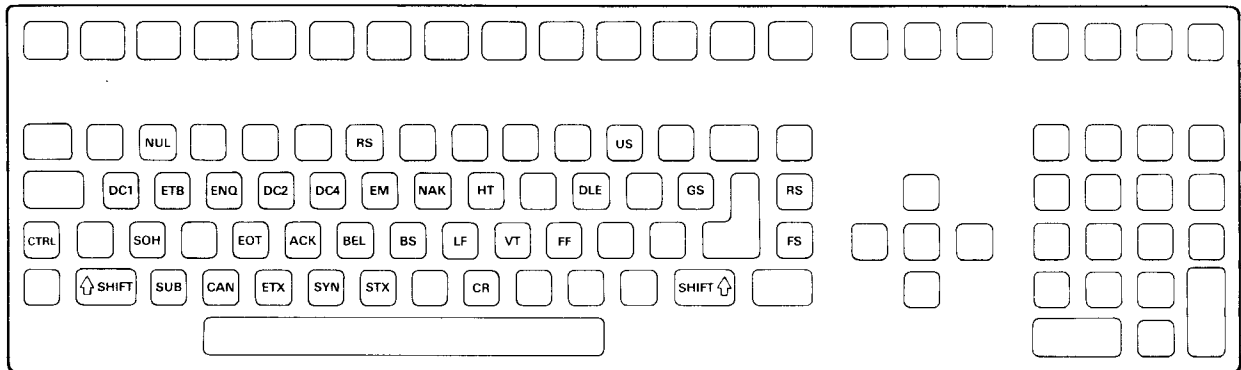

2229228-51

PROTECTED SHIFT CTRL

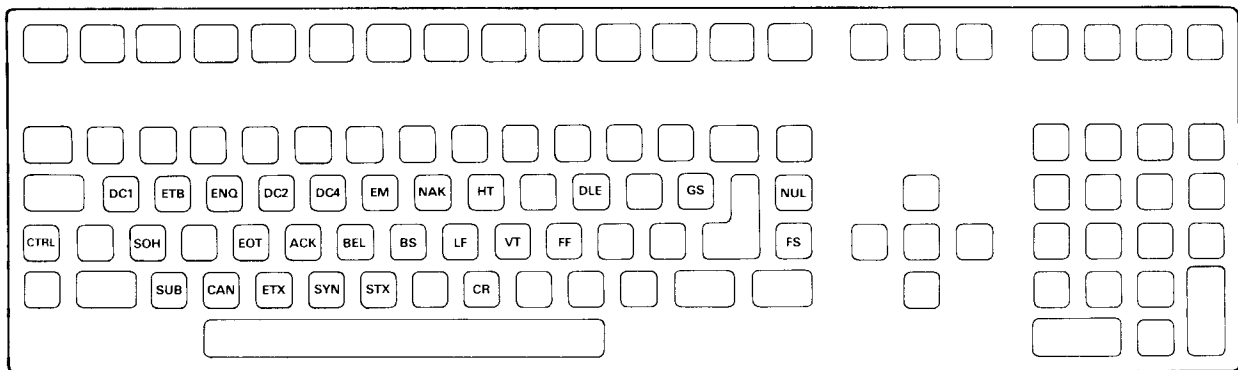

2229228-52

PROTECTED CTRL

Figure A-14. Terminal Control Code Keyboard Modes (Protected)

Appendix B

Codes and Character Sets

The tables in this appendix are provided to assist the systems programmer:

- US ASCII Character Codes
- US ASCII Control Code Functions
- Escape Sequence Commands
- Row and Column Addressing
- Move Box Row and Column Count Codes
- Repeat Count Values

B.1 US ASCII CHARACTER CODES

Table B-1 is a complete chart of US ASCII characters (ANSI control codes and displayable characters) with their hexadecimal notations.

Table B-1. US ASCII Character Codes

MSB LSB	0	1	2	3	4	5	6	7
0	NUL	DLE	SP	0	@	P	'	p
1	SOH	DC1	!	1	A	Q	a	q
2	STX	DC2	"	2	B	R	b	r
3	ETX	DC3	#	3	C	S	c	s
4	EOT	DC4	\$	4	D	T	d	t
5	ENQ	NAK	%	5	E	U	e	u
6	ACK	SYN	&	6	F	V	f	v
7	BEL	ETB	'	7	G	W	g	w
8	BS	CAN	(8	H	X	h	x
9	HT	EM)	9	I	Y	i	y
A	LF	SUB	*	:	J	Z	j	z
B	VT	ESC	+	;	K	[k	{
C	FF	FS	,	<	L	\	l	!
D	CR	GS	-	=	M]	m	}
E	SO	RS	.	>	N	^	n	~
F	SI	US	/	?	O	_	o	DEL

2229228-50

B.2 US ASCII CONTROL CODE FUNCTIONS

A list of control terms with meanings appropriate to functions of the Model 931 VDT is provided in Table B-2.

Table B-2. US ASCII Control Code Functions

Character/ Function		Character/Function	
ACK	acknowledge	FF	form feed
BEL	bell	FS	form mark
BS	backspace	GS	group separator
CAN	cancel	HT	horizontal tab
CR	carriage return	LF	line feed
DC1	transmit ON	NAK	negative acknowledge
DC2	—	NUL	time fill character
DC3	transmit OFF	RS	region mark
DC4	—	SI	shift in (select pri char set)
DLE	disconnect control	SO	shift out (select alt char set)
EM	end of medium	SOH	start of header
ENQ	enquiry (read ABM)	STX	start of text
EOT	end of transmission	SUB	parity error displayed
ESC	control sequence introducer	SYN	synchronous idle
ETB	end of block transmission	US	unit separator
ETX	end of text	VT	vertical tab

B.3 Escape Sequence Commands

The codes of Table B-3, when preceded by ESC (hex 1B), perform the specified functions. Arguments for the commands of Table B-3 must be selected from the indicated tables.

- ASC → Table B-1. Displayable ASCII characters (hex 20 through 7E)
- atr → Table 5-2. ASCII characters and Hex Codes for Display Attributes
- r/c → Table B-4. Row and Column Addressing
- num → Table B-5. Move Box Row and Column Count Codes
- cnt → Table B-6. Repeat Count Values

Table B-3. ASCII Value Actions Performed When Preceded by ESC

	0	1	2	3	4	5	6	7
0 Cmd #Par Table	NUL	DLE	Space	0	@ Read to Address	P Insert Char	'	p
1 Cmd #Par Table	SOH	DC1	! Fill Chr & Atr 1 + 1 ASC,atr	1	A Cursor Up	Q Delete Char	a Scroll Up	q
2 Cmd #Par Table	STX	DC2	" Chr Edt Bound	2	B Cursor Down	R Cursor Off	b Scroll Down	r
3 Cmd #Par Table	ETX	DC3	# Ln Edit Bound	3	C Cursor Right	S Cancel Output	c	s
4 Cmd #Par Table	EOT	DC4	\$ En/Dis Chr Bound	4 Set Dsp Attrib	D Cursor Left	T	d	t
5 Cmd #Par Table	ENQ	NAK	% Rep Atr to Address 1 + 2 atr,r/c	5 Read Cursor Pos	E	U	e	u
6 Cmd #Par Table	ACK	SYN	&	6 Read Status	F Write to Printer Var	V Cursor Blink "1" = Blk "0" = Sta	f	v

Table B-3. ASCII Value Actions Performed When Preceded by ESC (Continued)

	0	1	2	3	4	5	6	7
7 Cmd #Par Table	BEL	ETB	'	7	G Extend Write	W Var	g	w En/Dis PM Mode
8 Cmd #Par Table	BS	CAN	(Control Start	8	H Cursor Home 0	X	h	x Move Box 2 + 2 num,r/c
9 Cmd #Par Table	HT	EM) Control End	9	I Erase to End Of Line 0	Y Set Cursor Address 2 r/c	caret	y Alter Chr Set 1
A Cmd #Par Table	LF	SUB	*	: Kybd Lock 0	J Ers to End of Screen 0	Z	j Rep Atr N Times 1 + 1 atr,cnt	z
B Cmd #Par Table	VT	ESC	+	; Kybd Unlock	K	[k Rep Chr n Times 1 + 1 ASC,cnt	{ Attrib AND 1 atr
C Cmd #Par Table	FF	FS	,	< Erase Message 0	L Erase All 0	\		 Video On 0
D Cmd #Par Table	CR	GS	-	=	M Cursor On 0]	m	} Attrib OR 1 atr

Table B-3. ASCII Value Actions Performed When Preceded by ESC (Concluded)

	0	1	2	3	4	5	6	7
E Cmd	SO	RS	.	> Ers to Address	N Insert Line	^	n	~ Video Off
#Par Table				2 r/c	0			0
F Cmd	SI	US	/	? Rep Chr to Adr	O Delete Line	_	o	DEL
#Par Table				1 + 2 ASC,r/c	0			

Table B-4. Row and Column Addressing

Row or Column Number	ASCII Value	Hex Value	Row or Column Number	ASCII Value	Hex Value
1		20	25	8	38
2	!	21	26	9	39
3	"	22	27	:	3A
4	#	23	28	;	3B
5	\$	24	29	<	3C
6	%	25	30	=	3D
7	&	26	31	>	3E
8	'	27	32	?	3F
9	(28	33	@	40
10)	29	34	A	41
11	*	2A	35	B	42
12	+	2B	36	C	43
13	,	2C	37	D	44
14	-	2D	38	E	45
15	.	2E	39	F	46
16	/	2F	40	G	47
17	0	30	41	H	48
18	1	31	42	I	49
19	2	32	43	J	4A
20	3	33	44	K	4B
21	4	34	45	L	4C
22	5	35	46	M	4D
23	6	36	47	N	4E
24	7	37	48	O	4F

Table B-4. Row and Column Addressing (Concluded)

Row or Column Number	ASCII Value	Hex Value	Row or Column Number	ASCII Value	Hex Value
49	P	50	65	'	60
50	Q	51	66	a	61
51	R	52	67	b	62
52	S	53	68	c	63
53	T	54	69	d	64
54	U	55	70	e	65
55	V	56	71	f	66
56	W	57	72	g	67
57	X	58	73	h	68
58	Y	59	74	i	69
59	Z	5A	75	j	6A
60	[5B	76	k	6B
61	\	5C	77	l	6C
62]	5D	78	m	6D
63	^	5E	79	n	6E
64	—	5F	80	o	6F

Table B-5. Move Box Row and Column Count Codes

Number of Rows or Columns	ASCII Value	Hex Value	Number of Rows or Columns	ASCII Value	Hex Value
1	!	21	21	5	35
2	“	22	22	6	36
3	#	23	23	7	37
4	\$	24	24	8	38
5	%	25	25	9	39
6	&	26	26	:	3A
7	'	27	27	;	3B
8	(28	28	<	3C
9)	29	29	=	3D
10	*	2A	30	>	3E
11	+	2B	31	?	3F
12	,	2C	32	@	40
13	—	2D	33	A	41
14	.	2E	34	B	42
15	/	2F	35	C	43
16	0	30	36	D	44
17	1	31	37	E	45
18	2	32	38	F	46
19	3	33	39	G	47
20	4	34	40	H	48

Table B-5. Move Box Row and Column Count Codes (Concluded)

Number of Rows or Columns	ASCII Value	Hex Value	Number of Rows or Columns	ASCII Value	Hex Value
41	I	49	61]	5D
42	J	4A	62	^	5E
43	K	4B	63	_	5F
44	L	4C	64	'	60
45	M	4D	65	a	61
46	N	4E	66	b	62
47	O	4F	67	c	63
48	P	50	68	d	64
49	Q	51	69	e	65
50	R	52	70	f	66
51	S	53	71	g	67
52	T	54	72	h	68
53	U	55	73	i	69
54	V	56	74	j	6A
55	W	57	75	k	6B
56	X	58	76	l	6C
57	Y	59	77	m	6D
58	Z	5A	78	n	6E
59	[5B	79	o	6F
60	\	5C	80	p	70

Table B-6. Repeat Count Values

Desired Repeat Count	ASCII Value	Hex Value	Desired Repeat Count	ASCII Value	Hex Value
1		20	17	0	30
2	!	21	18	1	31
3	"	22	19	2	32
4	#	23	20	3	33
5	\$	24	21	4	34
6	%	25	22	5	35
7	&	26	23	6	36
8	'	27	24	7	37
9	(28	25	8	38
10)	29	26	9	39
11	*	2A	27	:	3A
12	+	2B	28	;	3B
13	,	2C	29	<	3C
14	-	2D	30	=	3D
15	.	2E	31	>	3E
16	/	2F	32	?	3F

Table B-6. Repeat Count Values (Concluded)

Desired Repeat Count	ASCII Value	Hex Value	Desired Repeat Count	ASCII Value	Hex Value
33	@	40	57	X	58
34	A	41	58	Y	59
35	B	42	59	Z	5A
36	C	43	60	[5B
37	D	44	61	\	5C
38	E	45	62]	5D
39	F	46	63	^	5E
40	G	47	64	_	5F
41	H	48	65	'	60
42	I	49	66	a	61
43	J	4A	67	b	62
44	K	4B	68	c	63
45	L	4C	69	d	64
46	M	4D	70	e	65
47	N	4E	71	f	66
48	O	4F	72	g	67
49	P	50	73	h	68
50	Q	51	74	i	69
51	R	52	75	j	6A
52	S	53	76	k	6B
53	T	54	77	l	6C
54	U	55	78	m	6D
55	V	56	79	n	6E
56	W	57	80	o	6F

Appendix C

Key Codes

This appendix contains complete quick-reference key code tables for the Model 931 VDT.

By pressing a data key in combination with a mode key or mode key combination, you make each data key transmit more than one code to the host. The mode keys **SHIFT**, **CAPS LOCK**, **CTRL**, and **ALT** each generate a mode-identifying character transmitted in advance of the data key character. (The mode character is transmitted only if the mode has changed since the last transmission.) Thus, each mode and data character combination generates a unique text string to the host.

When the terminal is placed in the keyboard test mode, all key codes (including mode characters) are translated to their ASCII-hex representation and are either displayed (offline) or transmitted to the host (online).

To obtain the ASCII character or hex code generated by a given key or key combination, refer to Figure C-1. There are six tables, one for each row of keys on the keyboard. Find the row of the key and the table number for that row. Enter the selected table and find the key code in the appropriate column: unshifted (normal mode) or shifted with one of the following keys depressed at the same time as the key in question (**SHIFT**; **CAPS LOCK**; **CTRL**; **SHIFT, CTRL**; and **ALT**). Raw key codes may also be examined for each key (unmapped codes). These codes are in the last column. They can be compared with and should match the codes generated at the keyboard that are copied to the screen when the terminal is placed in the keyboard test mode (see Section 7). ASCII characters are listed above hex notations. Entries shown as “.” have no assigned function.

Mode key codes are in Table C-7.

Note that when keyboard protection is enabled, some **ALT** and **CTRL** keys do not behave as described in the following tables. Refer to Section 4 for a complete description of the protected keyboard mode.

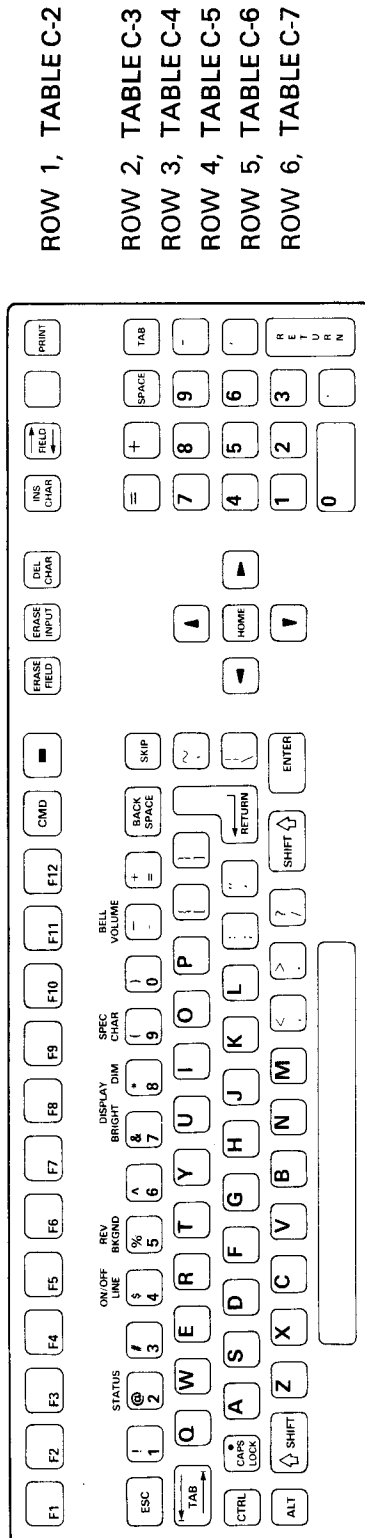

2229228-26

Figure C-1. Keyboard Reference for Key Code Tables

ROW 1, TABLE C-2
 ROW 2, TABLE C-3
 ROW 3, TABLE C-4
 ROW 4, TABLE C-5
 ROW 5, TABLE C-6
 ROW 6, TABLE C-7

Codes generated by mode keys and mode combinations are in Table C-3. Mode key codes are transmitted before data key codes only if the mode has changed since the last transmission. In the keyboard test mode, these codes become “visible” to the host and are not implemented.

Table C-1. Mode Key Codes

Code Transmitted		CAPS LOCK	SHIFT	ALT	CTRL
7 37	8 38	Off	Off	Off	Off
7 37	9 39	Off	Off	Off	On
7 37	A 41	Off	Off	On	Off
7 37	B 42	Off	Off	On	On
7 37	C 43	Off	On	Off	Off
7 37	D 44	Off	On	Off	On
7 37	E 45	Off	On	On	Off
7 37	F 46	Off	On	On	On
F 46	8 38	On	Off	Off	Off
F 46	9 39	On	Off	Off	On
F 46	A 41	On	Off	On	Off
F 46	B 42	On	Off	On	On
F 46	C 43	On	On	Off	Off
F 46	D 44	On	On	Off	On
F 46	E 45	On	On	On	Off
F 46	F 46	On	On	On	On

Table C-2. Key Codes—Row 1

Keycap	Normal	Shift	Caps Lock	Control	Shift/ Control	Alt	Keyboard Test Mode
F1	ESC i 1B 69 31	ESC i 1B 69 3D	ESC i 1B 69 31	1 31	6 5 36 35
F2	ESC i 1B 69 32	ESC i 1B 69 3E	ESC i 1B 69 32	2 32	6 6 36 36
F3	ESC i 1B 69 33	ESC i 1B 69 3F	ESC i 1B 69 33	3 33	6 7 36 37
F4	ESC i 1B 69 34	ESC i 1B 69 40	ESC i 1B 69 34	4 34	6 8 36 38
F5	ESC i 1B 69 35	ESC i 1B 69 41	ESC i 1B 69 35	5 35	6 9 36 39
F6	ESC i 1B 69 36	ESC i 1B 69 42	ESC i 1B 69 36	6 36	0 1 30 31
F7	ESC i 1B 69 37	ESC i 1B 69 43	ESC i 1B 69 37	7 37	0 2 30 32
F8	ESC i 1B 69 38	ESC i 1B 69 44	ESC i 1B 69 38	8 38	0 3 30 33
F9	ESC i 1B 69 39	ESC i 1B 69 45	ESC i 1B 69 39	9 39	0 4 30 34
F10	ESC i 1B 69 3A	ESC i 1B 69 46	ESC i 1B 69 3A	: 3A	6 A 36 41
F11	ESC i 1B 69 3B	ESC i 1B 69 47	ESC i 1B 69 3B	; 3B	0 5 30 35

Table C-2. Key Codes—Row 1 (Concluded)

Keycap	Normal	Shift	Shift/Control	Control	Control	Alt	Keyboard Test Mode					
F12	ESC 1B 69	< 3C	ESC 1B 69	H 48	ESC 1B 69	i 69	< 3C	ESC 1B 69	0 30	6 36
CMD	ESC 1B 68	h 68	ESC 1B 68	L 4C	ESC 1B 68	h 68	..	ESC 1B 68	ESC 1B 64	d 64	0 30	7 37
blank orange	ESC 1B 67	g 67	ESC 1B 67	e 65	ESC 1B 67	g 67	..	ESC 1B 67	ESC 1B 63	c 63	0 30	8 38
ERASE FIELD	ESC 1B 3D	= 3D	ESC 1B 3D	I 49	ESC 1B 3D	= 3D	..	ESC 1B 3D	ESC 1B 62	b 62	6 36	B 42
ERASE INPUT	ESC 1B 4B	K 4B	ESC 1B 4B	J 4A	ESC 1B 4B	K 4B	..	ESC 1B 4B	ESC 1B 61	a 61	6 36	C 43
DEL CHAR	ESC 1B 51	Q 51	ESC 1B 51	O 4F	ESC 1B 51	Q 51	..	ESC 1B 51	6 36	D 44
INS CHAR	ESC 1B 50	P 50	ESC 1B 50	P 50	ESC 1B 50	P 50	..	ESC 1B 50	2 32	F 46
FIELD	ESC 1B 74	t 74	ESC 1B 74	i 69	ESC 1B 74	t 74	..	ESC 1B 74	3 33	0 30
blank gray	ESC 1B 4E	N 4E	ESC 1B 4E	< 3C	ESC 1B 4E	N 4E	..	ESC 1B 4E	Transmit Break	..	6 36	4 34
PRINT	ESC 1B 57	W 57	ESC 1B 57	W 57	ESC 1B 57	W 57	..	ESC 1B 57	5 35	A 41

Table C-3. Key Codes—Row 2

Keycap	Normal	Shift	Caps Lock	Control	Shift/ Control	Alt	Keyboard Test Mode
ESC	ESC 1B	ESC f 1B 66	ESC 1B	4 1 34 31
1	1 31	! 21	1 31	7F	0 9 30 39
2	2 32	@ 40	2 32	..	NUL 00	Toggle Status Line	0 A 30 41
3	3 33	# 23	3 33	ESC * 1B 2A	0 B 30 42
4	4 34	\$ 24	4 34	On/Off Line	0 C 30 43
5	5 35	% 25	5 35	Reverse Background	0 D 30 44
6	6 36	^ 5E	6 36	..	RS 1E	..	0 E 30 45
7	7 37	& 26	7 37	Display Bright	0 F 30 46
8	8 38	* 2A	8 38	Display Dim	1 0 31 30
9	9 39	(28	9 39	SI or SO 0E or 0F	1 1 31 31

Table C-3. Key Codes — Row 2 (Concluded)

Keycap	Normal	Shift	Caps Lock	Control	Shift/ Control	Alt	Keyboard Test Mode
0	0)	0	1 2 31 32
-	30	29	30	1 3 31 33
=	2D	5F	2D	..	US 1F	Bell Volume Adjust	1 4 31 34
BACK SPACE	BS 08	BS 08	BS 08	1 5 31 35
SKIP	ESC 1B 73	ESC 1B 73	ESC 1B 73	ESC ; 1B 3B	1 6 31 36
=	=	=	=	ESC 1B 2C	1 7 31 37
+	+	+	+	ESC 1B 2D	1 8 31 38
SPACE	20	20	20	ESC 1B 2E	1 9 31 39
TAB	HT 09	ESC 1B 32	HT 09	ESC + 1B 2B	1 A 31 41

Table C-4. Key Codes—Row 3

Keycap	Normal	Shift	Caps Lock	Control	Shift/ Control	Alt	Keyboard Test Mode
TAB	HT 09	ESC 2 1B 32	HT 09	3 1 33 31
Q	q 71	Q 51	Q 51	DC1 11	DC1 11	..	3 2 33 32
W	w 77	W 57	W 57	ETB 17	ETB 17	..	3 3 33 33
E	e 65	E 45	E 45	ENQ 05	ENQ 05	..	3 4 33 34
R	r 72	R 52	R 52	DC2 12	DC2 12	..	3 5 33 35
T	t 74	T 54	T 54	DC4 14	DC4 14	..	3 6 33 36
Y	y 79	Y 59	Y 59	EM 19	EM 19	..	3 7 33 37
U	u 75	U 55	U 55	NAK 15	NAK 15	..	3 8 33 38
I	i 69	I 49	I 49	HT 09	HT 09	ESC A 1B 41	3 9 33 39
O	o 6F	O 4F	O 4F	SI 0F	SI 0F	..	3 A 33 41

Table C-4. Key Codes — Row 3 (Concluded)

Keycap	Normal	Shift	Caps Lock	Control	Shift/ Control	Alt	Keyboard Test Mode
P	p 70	P 50	P 50	DLE 10	DLE 10	..	3 B 33 42
[[5B	{ 7B	[5B	ESC 1B	ESC 1B	..	3 C 33 43
]] 5D	} 7D] 5D	GS 1D	GS 1D	..	3 D 33 44
,	, 60	~ 7E	, 60	NUL 00	RS 1E	..	3 E 33 45
UP ARROW	ESC 1B 41	ESC 1B 41	ESC 1B 41	4 0 34 30
7	7 37	7 37	7 37	2 7 32 37
8	8 38	8 38	8 38	2 8 32 38
9	9 39	9 39	9 39	2 1 32 31
-	- 2D	- 2D	- 2D	2 2 32 32

Table C-5. Key Codes — Row 4

Keycap	Normal	Shift	Caps Lock	Control	Shift/ Control	Alt	Keyboard Test Mode
A	a 61	A 41	A 41	SOH 01	SOH 01	..	4 2 34 32
S	s 73	S 53	S 53	DC3 13	DC3 13	..	4 3 34 33
D	d 64	D 44	D 44	EOT 04	EOT 04	..	4 4 34 34
F	f 66	F 46	F 46	ACK 06	ACK 06	..	4 5 34 35
G	g 67	G 47	G 47	BEL 07	BEL 07	..	4 6 34 36
H	h 68	H 48	H 48	BS 08	BS 08	ESC t 1B 74	4 7 34 37
J	j 6A	J 4A	J 4A	LF 0A	LF 0A	ESC D 1B 44	4 8 34 38
K	k 6B	K 4B	K 4B	VT 0B	VT 0B	ESC B 1B 42	4 9 34 39
L	l 6C	L 4C	L 4C	FF 0C	FF 0C	ESC C 1B 43	4 A 34 41
;	;	;	;	ESC i 1B 69	4 B 34 42
	3B	3A	3B	o 6F	

Table C-5. Key Codes — Row 4 (Concluded)

Keycap	Normal	Shift	Caps Lock	Control	Shift/ Control	Alt	Keyboard Test Mode
'	27	"	'	4 C 34 43
RETURN	CR OD	CR OD	CR OD	4 D 34 44
\	\ 5C	 7C	\ 5C	FS 1C	FS 1C	..	4 E 34 45
LEFT ARROW	ESC 1B 44	ESC 1B 44	ESC 1B 44	4 F 34 46
HOME	ESC 1B 48	ESC 1B 48	ESC 1B 48	5 0 35 30
RIGHT ARROW	ESC 1B 43	ESC 1B 43	ESC 1B 43	2 E 32 45
4	4 34	4 34	4 34	1 F 31 46
5	5 35	5 35	5 35	2 0 32 30
6	6 36	6 36	6 36	2 9 32 39
'	' 2C	' 2C	' 2C	2 A 32 41

Table C-6. Key Codes -- Row 5

Keycap	Normal	Shift	Caps Lock	Control	Shift/ Control	Alt	Keyboard Test Mode
Z	z 7A	Z 5A	Z 5A	SUB 1A	SUB 1A	..	5 2 35 32
X	x 78	X 58	X 58	CAN 18	CAN 18	..	5 3 35 33
C	c 63	C 43	C 43	ETX 03	ETX 03	..	5 4 35 34
V	v 76	V 56	V 56	SYN 16	SYN 16	..	5 5 35 35
B	b 62	B 42	B 42	STX 02	STX 02	..	5 6 35 36
N	n 6E	N 4E	N 4E	SO 0E	SO 0E	..	5 7 35 37
M	m 6D	M 4D	M 4D	CR 0D	CR 0D	ESC H 1B 48	5 8 35 38
,	' 2C	< 3C	' 2C	5 9 35 39

Table C-6. Key Codes — Row 5 (Concluded)

Keycap	Normal	Shift	Caps Lock	Control	Shift/ Control	Alt	Keyboard Test Mode
.	2E	> 3E	. 2E	5 B 35 42
/	/ 2F	? 3F	/ 2F	5 C 35 43
ENTER	ESC 1B	ESC 1B	ESC 1B	q 71	7 3 37 33
DOWN ARROW	ESC 1B	ESC 1B	ESC 1B	B 42	6 0 36 30
1	1 31	1 31	1 31	1 B 31 42
2	2 32	2 32	2 32	2 3 32 33
3	3 33	3 33	3 33	2 B 32 42

Table C-7. Key Codes—Row 6

Keycap	Normal	Shift	Caps Lock	Control	Shift/ Control	Alt	Keyboard Test Mode
SPACE	20	20	20	5 1
BAR				35 31
0	0	0	0	1 D
	30	30	30	31 44
.	2 C
	2E	2E	2E	32 43
RETURN	CR	CR	CR	1 E
	0D	0D	0D	31 45

Appendix D

Interfaces and Cables

D.1 INTRODUCTION

This appendix lists pin assignments for those installing a hybrid computer/peripheral system not covered in this manual. The following are included.

- Interface signal pin assignments
- Model 931 VDT COMM connector pin assignments
- Model 931 VDT AUX-1 connector pin assignments
- Cable pin assignments
- Extension cable pin assignments

D.2 INTERFACE SIGNAL PIN ASSIGNMENTS

Table D-1 lists signal pin assignments for Communications Interfaces 990/10A, (TI Part No. 2275975-0002, 0004), CI402 (TI Part No. 2303105-0001), CI403 (TI Part No. 2233050-0001).

Table D-1. EIA RS-232-C Interface Signal Pin Assignments

Interface Pinout Number	Circuit Type		Signal Name
	EIA	CCITT	
1	AA	101	Protective ground (GND)
2	BA	103	Transmitted data (TD)
3	BB	104	Received data (RCVD)
4	CA	105	Request to send (RTS)
5	CB	106	Clear to send (CTS)
6	CC	107	Data set ready (DSR)
7	AB	102	Signal ground (SGND)
8	CF	109	Received signal detector (DCD)

Table D-1. EIA RS-232-C Interface Signal Pin Assignments (Concluded)

Interface Pinout Number	Circuit Type		Signal Name
	EIA	CCITT	
9			Reserved
10			Reserved
11			Secondary request to send (SRTS)
12	SCF	119	Secondary received line signal detector (SDCD)
13	SCB		Analog loopback (ANLB)
14			New sync
15	DB		Transmission signal element timing (XCLK) (DCE)
16	SBD		Secondary received data
17	DD		Receiver signal element timing (RCLK)
18			Audio monitor (RES MODEM LD)
19	SCA		Secondary request to send (SRTS)
20	CD		Data terminal ready (DTR)
21	CG		Signal quality detector
22	CE	125	Ring indicator (RI)
23	CH/CI	111	Data signal rate selector
24	DA		Transmit signal element timing (DTE Source)
25			Carrier detect

D.3 MODEL 931 VDT COMM CONNECTOR PIN ASSIGNMENTS

Table D-2 lists pin assignments for the Model 931 VDT COMM(host connection) port.

Table D-2. Model 931 VDT COMM Connector Pin Assignments

Pinout Number	Circuit Type		Signal Name	Mnemonic
	EIA	CCITT		
1	AA	101	Protective ground	GND
2	BA	103	Transmitted data	TD
3	BB	104	Received data	RCVD
4	CA	105	Request to send	RTS
5	CB	106	Clear to send	CTS
6	CC	107	Data set ready	DSR
7	AB	102	Signal ground	SGND
8	CF	109	Received line signal	DCD
11			Secondary request to send	SRTS
19	SCA		Secondary request to send connected to pin 11	SDCD
20	CD		Data terminal ready	DTR
22	CE	125	Ring indicator	RI

D.4 MODEL 931 VDT AUX-1 CONNECTOR PIN ASSIGNMENTS

Table 7-4 lists pin assignments for the Model 931 VDT AUX (printer) port.

Table D-3. Model 931 VDT AUX-1 Connector Pin Assignments

Pinout Number	Circuit Type		Signal Name	Mnemonic
	EIA	CCITT		
1	AA	101	Protective ground	GND
2	BA	102	Transmitted data	TD
4	CA	103	Request to send	RTS
5	CB	104	Clear to send	CTS
6	CC	105	Data set ready	DSR
7	AB	106	Signal ground	SGND
12	SCF	119	Secondary received line signal detect	SDCD
20	CD		Data terminal ready	DTR

D.5 CABLE PIN ASSIGNMENTS

The following paragraphs list pin assignments for cables connecting the Model 931 VDT with Texas Instruments S300, S600, and S800 series computers in direct-connect and remote applications. Terminal/printer cable pin assignments are also listed.

D.5.1 Direct Connect Cable

The direct connect cable (TI Part No. 2303077-0001) connects the terminal with a Texas Instruments Small Business Systems 600 and 800 host computer.

Table D-4. Direct Connect Cable Pin Assignments

Host Signal	P1 Connector Pin # At Host End	P2 Connector Pin # At Terminal End	Terminal Signal
TD	1	3	RCVD
RCVD	2	2	TD
RTS	3	8	DCD
CTS	4		
DSR	5	20	DTR
DCD	6	4	RTS
		5	CTS
SRTS	7	12	SDCD
SDCD	8	19	SRTS
DTR	12	6	DSR
SGND	16	7	SGND
GND	Shell	Shield	Shell 1
	18 Pin Female	25 Pin Male	

D.5.2 Texas Instruments Host/Modem Cable

The Texas Instruments host/modem cable (TI Part No. 2303070-0003) interfaces modems with Texas Instruments S600 and S800 computer systems.

Table D-5. Host/Modem Cable Pin Assignments

Host Signal	P1 Connector Pin # Host End	P2 Connector Pin # Modem End	Modem Signal
TD	1	2	TD
RCVD	2	3	RCVD
RTS	3	4	RTS
CTS	4	5	CTS
DSR	5	6	DSR
DCD	6	8	DCD
SRTS	7	19	SRTS
SDCD	8	12	SDCD
NEWSYNC	9	14	NEWSYNC
XCLK	10	15	XCLK
RCLK	11	17	RCLK
DTR	12	20	DTR
RI	13	22	RI
EXTXCLK	14	24	EXTCLK
ANLB	15	13	ANLB
SGND	16	7	SGND
SPARE	17	10	SPARE
SPARE	18	23	SPARE
GND	Shell	Shield	Shell 1
	18 Pin Female		25 Pin Male

D.5.3 Host/Modem, Modem/Model 931 VDT Cable

This cable (TI Part No. 2532883-0001) connects a Model 931 VDT to a modem, or connects a modem to the Texas Instruments Small Business Systems 300 computer.

Table D-6. Host/Modem, Modem/Model 931 VDT Cable Pin Assignments

Host or Terminal Signal	P1 Connector Pin # at Host or Terminal End	P2 Connector Pin # at Modem End	Modem Signal
	Shell ———— Shield ———— Shell		
GND	1	1	GND
TD	2	2	TD
RCVD	3	3	RCVD
RTS	4	4	RTS
CTS	5	5	CTS
DSR	6	6	DSR
SGND	7	7	SGND
DCD	8	8	DCD
SRTS	11	11	SRTS
SDCD	12	12	SDCD
XCLK	15	15	XCLK
RCLK	17	17	RCLK
SRTS	19	19	SRTS
DTR	20	20	DTR
RI	22	22	RI
EXTCLK	24	24	EXTCLK
	25 Pin Male	25 Pin Male	

D.5.4 Host/Model 931 VDT Cable

The host/931 cable (TI Part No. 2233200-0001) is the fiber optics cable connecting the Model 931 VDT and the host computer. The following figure shows pins reserved on fiber optics cables.

Table D-7. Fiber Optics Cable Pin Assignments

Host FO Signal	P1 Connector Pin #	P2 Connector Pin #	Terminal FO Signal
TD	1	2	RCVD
RCVD	2	1	TD
2 fibers keyed			

D.5.5 Printer/Model 931 VDT or S300/Model 931 VDT Cable

The printer/931 cable (TI Part No. 2230504-0002) connects the Model 931 VDT to a printer or connects a Texas Instruments Small Business Systems 300 computer to a Model 931 VDT.

Table D-8. Printer/Model 931 VDT or S300/Model 931 VDT, Cable Pin Assignments

Host or Printer Signal	P1 Connector Pin # Printer End	P2 Connector Pin # Terminal End	931 Comm Signal
GND	1	1	GND
TD	2	3	RCVD
RCVD	3	2	TD
RTS	4	8	DCD
CTS	5		
DSR	6	20	DTR
SGND	7	7	SGND
DCD	8	4	RTS
		5	CTS
SRTS	11	12	SDCD
SDCD	12	11	SRTS
CLK	15	17	RCLK
RCLK	17	15	XCLK
EXTXCLK	24		
DTR	20	6	DSR
	25 Pin Male	25 Pin Male	

D.6 EXTENSION CABLE PIN ASSIGNMENTS

The EIA extension cables (TI Part No. 2303071-0002, 0004) and the FO extension cables (TI Part No. 2233201-0002, 0003, 0004,) are used as extension cables only. Each connects to a cable at one end and a unit (such as a terminal or computer) at the other.

Table D-9. EIA Extension Cable 2303071 Pin Assignments

Cable Signal	P1 Connector Pin # Cable End	P2 Connector Pin # Terminal End	931 Comm Signal
	GND Shell ————— Shield ————— Shell 1		
GND	1	1	GND
TD	2	2	TD
RCVD	3	3	RCVD
RTS	4	4	RTS
CTS	5	5	CTS
DSR	6	6	DSR
SGND	7	7	SGND
DCD	8	8	DCD
BIAS	9	9	BIAS
SRTS	11	11	SRTS
DTR	20	20	DTR
	25 Pin Female	25 Pin Male	

Table D-10. Fiber Optics Extension Cable 2233201 Pin Assignments

FO Signal	P1 Connector Pin # Cable End	P2 Connector Pin # Terminal End	931 FO Signal
TD	1	2	RCVD
RCVD	2	1	TD
	2 fibers keyed		

Glossary

Abort — To end a program and return control to the operating system, usually when a mistake or malfunction occurs.

Acknowledge Character (ACK) — A transmission control character sent by a receiver as an affirmative response to a sender.

Address — A number that represents a register, a memory location, or some other data source or destination.

Alphanumeric — Term for all characters A through Z and numbers 0 through 9. Used to describe a key group that enters characters and numbers.

AND — A binary function that is ON if (and only if) all its inputs are ON.

ASCII — An eight-level (seven bits and a parity bit) code that is the American Standard Code for Information Interchange.

Baud Rate — A measure of data transfer rate that is the number of discrete conditions or signal events per second.

Bit — An abbreviation for binary digit; the smallest unit of information in a binary system of notation.

Block — A contiguous series of consecutive bytes.

Byte — A sequence of eight binary digits (bits) that operate as a unit and constitute the smallest addressable unit.

Carrier — A continuous frequency capable of being modulated or impressed with a signal.

CCITT — The Consultative Committee for International Telephone and Telegraph of the United Nations. The committee's interface standard is similar to the EIA RS-232-C standard.

Character — One symbol of a set of elementary symbols, such as a letter of the alphabet. A character is made up of seven bits (ASCII and CCITT code).

CPS — A measure of data transfer rate equal to the number of characters per second.

CPU (Central Processing Unit) — Unit of a computer that includes circuits controlling the interpretation and execution of instructions.

Code — A system of symbols (bits) for representing data (characters).

Control Character — A character whose occurrence in a particular context initiates, modifies, or stops a control function (contrast with graphic character).

Cursor — A movable spot of light on the screen of a display unit, usually indicating where the next character will be entered.

Data — A character or command that represents information.

Data Communication — The movement of computer generated information by means of communication transmission systems.

Data Set — A device that performs modulation/demodulation and control functions to enable data transmission over telephone lines between two data processing devices (same as modem).

Default Values — A set of base values or original values that the terminal assumes under certain conditions.

Display — A visual presentation of information.

Display Attribute — A characteristic defined on a character-by-character basis that, when included with the character displayed, changes the character image displayed on the screen.

Display Memory — The RAM where the display characters and attributes are stored.

Duplex — Describes two operations, such as transmitting and receiving. Full duplex means simultaneous transmission and reception.

Echo — Data entered on the keyboard is sent to the host computer and returned to the Model 931 VDT for display.

EIA — Electronics Industries Association whose standard RS-232-C defines interconnection interfaces for terminals.

Field — A character or group of characters that can be considered one data item.

Graphic Characters — Consist of all letters, numbers, the comma, the period and all device-independent symbols that generally have no special meaning unless used in the context of a program or data field (compare to control characters).

Hertz — A unit of frequency equal to one cycle per second. Abbreviated Hz.

Hexadecimal — Pertaining to a selection, choice, or condition that has 16 possible values or states. These values or states contain ten digits and six letters, A through F. Hexadecimal digits are equivalent to a power of 16.

Host Computer (also Host) — The primary or controlling computer to which the Model 931 VDT is connected by cable or communication link.

Interface — Interconnection between two pieces of equipment that have different functions.

LED (Light Emitting Diode) — A small, solid-state device that emits light when a current is applied.

Line, Communication Link — Describes cables, modems, telephone lines, etc., over which data is transmitted to and received from the terminal. Also referred to as the line.

Local — See offline.

Message — In data communications, information that contains a predefined beginning and end.

Modem — Same as data set (acronym for MODulator/DEModulator).

New Line — A function that causes the display position to move to the first position of the next line.

Non-Volatile Memory — Memory that retains information when the terminal power is off.

Null (NUL) — A control character that can be inserted into or removed from a sequence of characters without affecting the meaning of the sequence; however, the control of equipment or the format can be affected by this character.

Numeric Character — Any number 0 through 9, comma, period, space, dollar mark, plus sign and minus sign.

Offline (Local) — Describes equipment or devices that can be connected to the communication link but do not transmit or receive data.

Online — Describes equipment or devices connected to the communication link and transmitting and receiving data as defined by the applicable communication protocol.

OR — A binary function logical argument that is ON if one input is ON.

Parameter — A predefined argument for a command.

Parity — Equal value in the check digit of the transmitted and received data.

Parity Check — Addition of non-information bits to data, making the number of ones in each grouping of bits either always odd for odd parity or always even for even parity. A transmission error can then be detected by checking each group of bits received for correct parity.

Protocol — A formal set of conventions or rules governing the format, timing, and error control facilitating message exchange between two communicating processes.

RAM — Random-access memory.

ROM — Read-only memory.

Screen (Display) — The total display of the CRT as the operator views the screen, minus the status line.

Glossary

Scrolling — The continuous vertical or horizontal movement of data across the screen.

Select — To activate the control and data channels to and from a unit, device, or circuit before use in that state.

Terminal — A device or computer that can be connected to a local or remote host system, and for which the host system provides computational and data access services.

Text — A sequence of characters.

Alphabetical Index

Introduction

HOW TO USE INDEX

The index, table of contents, list of illustrations, and list of tables are used in conjunction to obtain the location of the desired subject. Once the subject or topic has been located in the index, use the appropriate paragraph number, figure number, or table number to obtain the corresponding page number from the table of contents, list of illustrations, or list of tables.

INDEX ENTRIES

The following index lists key words and concepts from the subject material of the manual together with the area(s) in the manual that supply major coverage of the listed concept. The numbers along the right side of the listing reference the following manual areas:

- Sections — Reference to Sections of the manual appear as “Sections x” with the symbol x representing any numeric quantity.
- Appendixes — Reference to Appendixes of the manual appear as “Appendix y” with the symbol y representing any capital letter.
- Paragraphs — Reference to paragraphs of the manual appear as a series of alphanumeric or numeric characters punctuated with decimal points. Only the first character of the string may be a letter; all subsequent characters are numbers. The first character refers to the section or appendix of the manual in which the paragraph may be found.
- Tables — References to tables in the manual are represented by the capital letter T followed immediately by another alphanumeric character (representing the section or appendix of the manual containing the table). The second character is followed by a dash (-) and a number.

Tx-yy

- Figures — References to figures in the manual are represented by the capital letter F followed immediately by another alphanumeric character (representing the section or appendix of the manual containing the figure). The second character is followed by a dash (-) and a number.

Fx-yy

- Other entries in the Index — References to other entries in the index preceded by the word “See” followed by the referenced entry.

- ABM 5.13.4
- AC:
 - Check 2.5.7
 - Receptacle F2-11
 - Power Cord 2.5.8
- ALT T6-2, T6-3, F6-4, Appendix A
 - Keyboard F6-4, FA-11
- Alternate Character Set .. 5.7.2, Appendix A
- Alternate Status Line 5.11.3, 6.2.3
- Attribute Commands 5.6
 - AND and OR 5.6.1.2
 - Set Display Attribute 5.6.1.1
 - Repeat Attribute to Address
 - Command 5.6.3
 - Repeat Attribute N Times 5.6.4
- Attributes:
 - Character Blank T5-2, 5.6
 - Character Blink T5-2, 5.6
 - High Intensity T5-2, 5.6
 - Reverse Image Character T6-3
 - Underline Character T5-2, 5.6
- Auxiliary (AUX)
 - Port T2-7, F2-10, 2.5.5, 4.4, 4.4.1
- Aux Configuration 4.4
 - Busy F6-2
 - Enable 4.4
 - Menu 4.4.2
 - Offline 6.4, T6-3
 - Offline Data Abort 4.4
 - Online 6.4, T6-2
 - Parity 4.4
 - RDY F6-1, 4.4
 - Protocol 4.4
 - Speed 4.4
- Aux Device Control Commands
 - Cancel Output 5.10.3
 - Write Data to Device 5.10.1
 - Write Data to Device and Printer
 - Acknowledge 5.10.2
- AUX-1 Port F2-7

- Backspace Command 5.2.4
- B-pole 5.14.3, F7-4, 7.3.4
- Base: Adjustable-Tilt .. 2.4.1, F2-3, F2-4, F2-5
- Battery 7.2.1
- Baud Rate 4.3.2, 4.4.2, T5-3, T5-4
- Bell Command 5.2.3, T6-3
- Bell 212A Modem 3.6, T3-7
- Bit Pattern F5-1, F5-2
- Brightness 6.4, F6-4
- BTY 7.2.1

- Cables:
 - Auxiliary Output 2.5.5, F2-10
 - Connections 2.5.5, T3-1, T3-2, Appendix D
 - EIA Communications Cable ... F2-8, 2.5.1
 - Fiber-Optics Cable 2.5.2
 - Extension Lengths 3.5, Appendix D
 - Pin Assignments Appendix D
- Cancel Printer Output 5.10.3
- CAPS LOCK 6.3, T6-2, Appendix A
- Cleaning 6.6
- Carriage Return (CR) Command 5.2.5
- Character
 - Attributes F7-4, T5-1
 - Blank 5.6, F7-4
 - Blink 5.6, F7-4
 - Cell T1-1, T2-1
 - Editing Extent Boundary
 - Command 5.5.5.2
 - Insert/Delete Commands .. 5.5.5.4, 5.5.5.5
 - Sets 5.7, Appendix A
- Character Set Selection Commands 5.7
 - Select and Enter Alternate Character
 - Set 5.7.1
 - Select Alternate Character Set 5.7.2
 - Select Primary Character Set 5.7.3
- Checkout Procedures 2.6
- Codes, Key Appendix C
- Commands, Miscellaneous 5.15
- Communications Section 3
 - Extension Cables 3.5
 - Interfaces 3.3, T3-1, T3-2, T3-3, 3.4, Appendix D
 - Local Configurations 3.3
 - Port 4.3
 - Recommended Modem Settings 3.6
 - Remote Configurations 3.4
 - Types of Installations 3.2
- Comm 4.2, 4.3, 6.2.2, T6-1
 - Busy 6.2.2.2, F6-1, T6-1
 - Conn 6.2.2.2, F6-1, T6-1
 - DCD 6.2.2.1, F6-1, T6-1
 - Disc 6.2.2.1, F6-1, T6-1
 - DSR 6.2.2.1, F6-1, T6-1
 - Loopback 6.2.2.1, F6-1, T6-1
 - Menu 4.3.2
 - Parity 4.3.2
 - Port 4.3, 2.2
 - Protocol 4.3
 - Receive DC1/DC3 4.3.2
 - Receive Parity Check 4.3.2
 - Rng 4.3, 6.2.2, T6-1
 - Rdy 6.2.2, F6-2
 - Speed 4.3.2
 - Transmit Block Delay 4.3.2
 - Transmit Block Size 4.3.2
- Configuration (Config) Section 4
- Configuration Commands 5.13
 - Define ABM 5.13.4
 - Define Aux Parameters 5.13.2.T5-4
 - Define Communication
 - Parameters 5.13.1, T5-3
 - Define Operational
 - Parameters 5.13.3.T5-5
 - Enable/Disable Personality Module
 - Mode 5.13.5
 - Reset Nonvolatile Memory 5.13.6
- Container Contents F2-1

- Control End Command 5.15.2
- Control Start Command 5.15.1
- Cursor T1-1, 5.3
- Attributes T1-1, 5.3.1, 5.3.2, 5.3.3
- Control Commands 5.3
- Down Command 5.3.4
- Enable/Disable Cursor Blink
 Command 5.3.3
- Features T1-1
- Home Command 5.3.5
- Keys F6-3, 6.3
- Left Command 5.3.6
- Off Command 5.3.1
- On Command 5.3.2
- Right Command 5.3.7
- Set Cursor Address Command 5.3.9
- Up Command 5.3.8
- Wrap 5.13.3, TA-3
- Count Overflow 5.12.3, T5-2
- CTRL 6.3, T6-2, FA-13

- Danish/Norwegian Keyboard FA-2
- DCD 6.2.2.2, T6-1, F6-2
- Delete:
 - Character Command 5.5.5.5
 - Line Command 5.5.4.3
- Device Control 1 (DC1) Command 5.2.2
- Device Control 3 (DC3) Command 5.2.1
- Device Service Routine (DSR) .. F6-2, 6.2.2.2
- Diag Execute Menu 7.3
- Loopback 7.3.7
- Keyboard Test 7.3.8
- Diagnostic Commands Section 7
- Diagnostics
 - Barberpole Test F7-4, 7.3.4
 - Blank Display 7.2.3
 - Communications 7.2.4
 - Continuous 7.3.6
 - Internal 7.3
 - Keyboard Test 7.3.8
 - Loopback Test 7.3.7
 - Malfunction Categories 7.2.2
 - N-V RAM Test 7.3.3
 - Online Confidence Tests 7.4
 - RAM Test 7.3.2
 - ROM Test 7.3.1
 - Pattern 7.3.5
 - Printer 7.2.5
 - Self-Tests 7.2.1
 - Troubleshooting 7.2
- Dimensions F2-2, T2-1
- Direct Connect 3.3
- Display (Dsply) T2-1, 4.5, F6-1
- Attributes T2-1, 5.6
- Bit Pattern Settings T5-2, F5-1
- Error Messages 7.2.1
- Frequency T1-1, 4.5
- Screen T1-1, 6.2
- Screen Adjust Pattern 7.3.5
- Dsply Freq 4.5
- Display Screen Features T1-1

- Edit Commands 5.5
- Enable/Disable Personality Module
 Command 5.13.5
- Enhanced Character Definition T1-1
- Enquiry 5.12.4
- Enter Keyboard Test Mode 7.3.8
- Environmental Considerations 2.1
- Erase Commands 5.4
- All 5.4.3
- To Address 5.4.4
- To End of Line 5.4.1
- To End of Screen 5.4.2
- Execute RAM Test 7.3.2
- Exit Keyboard Test Mode Command .. 7.3.8
- Establishing Communications 2.5
- Extension Cables 3.5, Appendix D
- External Loopback Test 7.3.7

- Fault Isolation Indicators .. 7.2.3, F7-1, F7-2
- FDPX 4.3.2
- FDPX = RC(Rdy ± On) 4.3.2
- FDPX = RC(Rdy ± Off) 4.3.2
- Fiber Optics 2.5.2, 3.3, T3-2
- Cable T3-2, F2-9
- Interface T3-2
- Port F2-9
- Fill Character and Attribute
 Command 5.5.5.3
- French Data Processing
 Keyboard FA-3
- French Word Processing
 Keyboard FA-4
- Fuse F7-2, 7.2.3
- Housing 7.2.3
- Replacement 7.2.3

- German/Austrian Keyboard FA-5

- High Intensity T5-1, 5.6
- Hexadecimal Section 5, Appendix B
- Host Commands Section 5
- Attribute 5.6
- Aux Device Control 5.10
- Character Set Selection 5.7
- Configuration 5.13
- Cursor Control 5.3
- Diagnostic 5.14
- Erase 5.4
- Keyboard 5.8
- Miscellaneous 5.15
- Screen Editing 5.5
- Status Line Control 5.11
- Terminal Control 5.2
- Terminal Reporting 5.12
- Video 5.9
- Host Message Area F6-2, 5.11.2
- Modem Cable 3.4, T3-5
- 931 Cable T3-1, T3-2, T3-3

- Insert Character Command 5.5.5.4

- Insert Line Command 5.5.4.2
- Installation Section 2
- Installations, Types 3.2
- Interfaces 3.3, 3.4, 2.5.1, Appendix D
 - Direct Connect 3.3, 2.5.1
 - Fiber Optics 3.3, 2.5.2
 - Cables Section 3, Appendix D
- Interface Signal Pin
 - Assignments Appendix D
- Internal Diagnostic Tests 7.3
- International Keyboards Appendix A
 - Danish/Norwegian FA-2
 - French Data Processing FA-3
 - French Word Processing FA-4
 - German/Austrian FA-5
 - Spanish FA-6
 - Swedish/Finnish FA-7
 - Swiss FA-8
 - United Kingdom FA-9
- Keyboard F2-6, 6-3, F6-3
 - Angle Adjustment F2-6, 2.4.2
 - Cable 2.4.4
 - Command Functions Appendix A
 - Control Functions Appendix A
 - Convenience Adjustments Appendix A
 - Data Entry and Editing Appendix A
 - Description 6.3, F6-3
 - Features T1-1
 - International Appendix A
 - Lock Command 5.8.1
 - Selections Appendix A
 - ALT 6.3, 6.4, T6-3, Appendix A
 - CAPS LOCK Appendix A
 - CTRL Appendix A
 - Normal Appendix A
 - SHIFT Appendix A
 - SHIFT, ALT Appendix A
 - SHIFT, CTRL Appendix A
 - Test 7.3.8
 - Unlock Command 5.8.2
 - Use 6.3, Appendix A
- Keyboard Error Message 7.2.1
- Keyboard Failure Message 7.2.1
- Key Codes Appendix C
- Labelled Keystrip 6.4, T6-3
- Line Drawing Characters Appendix A
- Line:
 - Insert/Delete Commands 5.5.4
 - Feed Command 5.2.5
- Local Configurations F3-1, 3.3
- Lowercase Descenders F7-4
- Main Display Area F6-1, 6.2.1
- Miscellaneous Commands 5.15
 - Control End 5.15.2
 - Control Start 5.15.1
- Modems 3.4, Appendix D
 - Cable T3-4, T3-5, Appendix D
 - Settings 3.6
 - Move Box Command 5.5.3
- National Electrical Code 2.5.8
- National Electrical Manufacturers
 - Association 2.5.8
- No Communications 7.2.4
- No Display 7.2.3
- No Print 7.2.5
- Nonvolatile Memory 7.3.3
 - Reset 7.3.3
- Nonvolatile RAM 7.3.3
- Numeric Group 6.3, F6-3, Appendix A
- Offline (Offln) 6.2.2, F6-2, T6-1
- Online (Onln) 6.2.2, F6-2, T6-1
- Operation Section 6
- Operational Parameters 5.13.3
- Operator Adjustments 6.4, T6-3
- Parity 4.3.2, 4.4.1, 5.13.1, 5.13.2
- Personality Module 5.13.5
- Pin Assignments
 - Aux Port Appendix D
 - Cable Appendix D
 - Comm Port Appendix D
 - Extension Cable Appendix D
 - Interface Appendix D
 - Power T2-1, 2.5.7, 2.5.8
 - Cord 2.5.8
 - Up 2.6
- Power-Good LED 7.2.3, F7-1
- Primary Status Line Format 6.2.2
- PRINT 4.4.1
- Printer
 - Acknowledge 5.10.2
 - 931 Cable 2.5.5
 - Connections 2.5.5
 - Diagnosis 7.2.5
 - Installation 2.5.5
- Programmer Configuration 4.2
- Programming Section 5
- Protocol 4.3.2, 4.4.1
- RAM Test 7.3.2
- Read:
 - Cursor Position 5.12.2
 - Status 5.12.3
 - To Address 5.12.1
- Receive LED 7.2.4, F7-3
- Remote Configurations 3.2, 3.4, Appendix D
- Repeat:
 - Attribute 5.6.3, 5.6.4
 - N Times 5.6.4
 - To Address 5.6.3

- Repeat:
 - Character 5.5.6.1, 5.5.6.2
 - N Times 5.5.6.2
 - To Address 5.5.6.1
- Report Terminal ID 5.12.5
- Restore Primary Status Line 5.11.4
- RETURN F6-3, Appendix A
- Reverse Channel 4.3.2, 4.4.2
- Reverse Screen Image 6.4, T6-3, F7-4
- ROMs, Verify All 7.3.1
- Screen Editing Commands 5.5
 - Delete Character 5.5.5.5
 - Delete Line 5.5.4.3
 - Insert Character 5.5.5.4
 - Insert Line 5.5.4.2
 - Move Box 5.5.3
 - Repeat Character N Times 5.5.6.2
 - Scroll Down 5.5.1
 - Scroll Up 5.5.2
- Select
 - Alternate Character Set 5.7.2
 - Character Editing Extent Boundary 5.5.5.2
 - Fill Character and Attribute 5.5.5.3
 - Line Editing Extent
 - Boundary 5.5.4.1
 - Primary Character Set 5.7.3
- Self-Test 7.2.1
 - Failed 2.6.1
 - LED F7-1
- Set Cursor Address 5.3.9
- Set Display Attribute 5.6.1.1
- SHIFT 6.3, T6-2, Appendix A
 - and ALT 6.3, T6-2, Appendix A
 - and CTRL 6.3, T6-2, Appendix A
- Space Requirements 2.1
- Spanish Keyboard FA-6
- Specifications, Installation T2-1
- Special Function Keys 6.3, F6-3
- Standby 2.6.2
- Status
 - Byte Code Format F5-2
 - Display 6.2.2, F6-2
- Status Line 6.2.2, F6-2
 - Aux T6-1, F6-2, 6.2.2
 - Comm T6-1, F6-2, 6.2.2
 - DCD T6-1, F6-2, 6.2.2
 - DSR T6-1, F6-2, 6.2.2
 - Offline T6-1, F6-2, 6.2.2
 - Online T6-1, F6-2, 6.2.2
- Status Line Control Commands
 - Erase Message 5.11.2
 - Restore Primary Status Line 5.11.4
 - Write to Message Area 5.11.1
 - Write to and Select Alternate Status
 - Line 5.11.3
- Status Byte Code Format T5-2, F5-2
- Storage Specifications T2-1
- Swedish/Finnish Keyboard FA-7
- Swiss Keyboard FA-8
- TAB Key F6-3, 6.3
- Temperature T2-1, 2.3
- Terminal Adjustments 6.4
 - Bell Volume F6-4, T6-3
 - Display Dim F6-4, T6-3
 - Display Bright F6-4, T6-3
 - On/Offline F6-4, T6-3
 - Reverse Background F6-4, T6-3
 - Status F6-4, T6-3
- Terminal
 - Control Commands 5.2
 - Features 1.2, 6.2, 6.3
 - Status Area 6.2.2, F6-2
- Reporting Commands 5.12
 - Read to Address 5.12.1
 - Read Cursor Position 5.12.2
 - Read Status 5.12.3
- Enquiry 5.12.4
 - Report Terminal ID 5.12.5
- Text Editing Boundary 5.5.4.1, 5.5.5.1
- Tilt-Base F2-3, F2-4, F2-5
- Transmit LED 7.2.4, F7-3
- Troubleshooting, General 7.2
- Underline T5-1, F5-1, 5.6, F7-4
- United Kingdom Keyboard FA-9
- Unpacking 2.2, 2.2.2
- US Character Sets Appendix B
- Ventilation T2-1, 2.3
- Verify All ROMs 7.3.1
- Video Display Unit (VDU)
 - Back Panel 2.4.3, F2-7
 - Description 6.2
 - Main Display Area 6.2.1
 - Status Line 6.2.2
 - Host Message Area 6.2.2.1
 - Terminal Status Area 6.2.2.2
- Video:
 - Off Command 5.9.1
 - On Command 5.9.2
- Voltage 2.5.8
 - Requirement Label F2-7
- Warm-Up 2.6.1
- Weight T2-1
- Write Commands
 - Data to Device Command 5.10.1
 - To and Select Alternate Status
 - Line 5.11.3
 - To Message Area Command 5.11.1

